

0RQB-15Y05X

Isolated DC-DC Converter

The 0RQB-15Y05X is an isolated DC/DC converter providing 15 W of output power from a wide input range (24 V, 48 V, 72 V, 96 V, 110 V typical). Standard features include remote on/off, input under-voltage protection, output over-voltage protection, over current and short circuit protection.

This converter can also provide a 5 V/5 mA auxiliary supply.

When a large hold-up capacitor is added, the converter can still work up to 12 ms when the input supply is interrupted.

Conformal coated PCB is used for environmental ruggedness.

Key Features & Benefits

- 24/48/72/96/110 VDC Input
- 5 VDC @ 3 A Output
- Reinforced Isolation
- High Efficiency
- Hold-up Function
- Remote ON/OFF
- Conformal Coated
- Input Under-Voltage Protection
- Output Over-Voltage Protection
- Over Current and Short Circuit Protection
- 5V Auxiliary Supply at Primary Side
- Wide Input Range (24 V, 48 V, 72 V, 96 V, 110 V typical)
- Approved to EN 60950-1
- Approved to EN 62368-1
- Class II, Category 2, Isolated DC/DC Converter (refer to IPC-9592B)



Applications

- Industrial
- Railways

1. MODEL SELECTION

MODEL NUMBER	OUTPUT VOLTAGE	INPUT VOLTAGE	MAX. OUTPUT CURRENT	MAX. OUTPUT POWER	TYPICAL EFFICIENCY
ORQB-15Y05X	5 VDC	24/48/72/96/110 VDC	3 A	15 W	76%

NOTE: Add "G" suffix at the end of the model number to indicate Tray Packaging.

PART NUMBER EXPLANATION

0	R	QB	-	15	Y	05	X	y
Mounting Type	RoHS Status	Series Name		Output Power	Input Range	Output Voltage	Logic status	Package Type
Through hole mount	RoHS	1/4th Brick		15 W	24/48/72/96/110 V	5 V	X – Active low, without HSK	G – Tray package

2. ABSOLUTE MAXIMUM RATINGS

PARAMETER	DESCRIPTION	MIN	TYP	MAX	UNITS
Continuous non-operating Input Voltage		-0.3	-	160	V
Remote On/Off		-0.3	-	15	V
Operating Temperature	Hot spot temperature, see Thermal Derating Curves section	-40	-	105	°C
Thermal Resistance	Module to ambient	-	4	-	°C/W
Storage Temperature		-40	-	125	°C
Altitude		-	-	2000	m

NOTE: Ratings used beyond the maximum ratings may cause a reliability degradation of the converter or may permanently damage the device.

3. INPUT SPECIFICATIONS

All specifications are typical at 25°C unless otherwise stated.

PARAMETER	DESCRIPTION	MIN	TYP	MAX	UNIT
Operating Input Voltage range 1	Fully functioning for long term operation.	16.8	24		V
			48		V
			72	137.5	V
			96		V
			110		V
Operating Input Voltage range 2	Full function is not guaranteed but undamaged for 1s operation.	14.4 137.5	-	16.8	V
			-	154	V
Operating Input Voltage range 3	Full function is not guaranteed but undamaged for 0.1 s operation.	12.9	-	14.4	V
Input Voltage Rising Slope		-	-	2	V/ms
Input Current (full load)		-	-	2.0	A
Input Current (no load)	V _{in} = 24 V, T _a = 25°C	-	-	110	mA
Remote Off Input Current		-	-	40	mA
Input Reflected Ripple Current (rms)	With simulated source impedance of 10 μH, 5 Hz to 20 MHz. Use two 100 μF / 250 V electrolytic capacitors with ESR = 0.5 R max, at 200 kHz @ 25°C.	-	-	20	mA
Input Reflected Ripple Current (pk-pk)		-	-	60	mA
Turn-on Voltage Threshold		14.5	15.2	16	V
Turn-off Voltage Threshold		12.5	13.2	14	V

CAUTION: This converter is not internally fused. An input line fuse must be used in application. Recommend a input fast-acting fuse with Typical of 3 A on system board. Refer to the fuse manufacture's datasheet for further information.

4. OUTPUT SPECIFICATIONS

All specifications are typical at nominal input, full load at 25°C unless otherwise stated.

PARAMETER	DESCRIPTION	MIN	TYP	MAX	UNIT
Output Voltage Set Point		4.9	5	5.1	V
Load Regulation		-	-	10	mV
Line Regulation		-	-	10	mV
Regulation Over Temperature		-	-	60	mV
Output Ripple and Noise (Pk-Pk)	With a 100 µF ceramic and a 100 µF electrolytic capacitors at output.	-	30	55	mV
Output Ripple and Noise (RMS)		-	3	10	mV
Output Ripple and Noise(Pk-Pk) under worst case		-	32	-	mV
Output Current Range		0	-	3	A
Output DC Current Limit		4	5	5.5	A
Rise Time		-	-	28	ms
Turn on Time	Ton (Enable form Vin)	-	-	1100	ms
	Ton (Enable form ON/OFF)	-	-	110	ms
Overshoot at Turn on		0	-	3	%
Output Capacitance	Typically 50% ceramic and 50% electrolytic capacitors.	200	-	1000	µF
5V Auxiliary Supply Source Current	At primary side.	-	-	5	mA
<i>Transient Response</i>					
ΔV 50%~75% of Max Load		80	105	130	mV
Settling Time	Vin = 24 V, 0.1 A/µs, a 100 µF ceramic and a 100 µF electrolytic capacitors are near the brick output.	0.04	0.08	0.12	ms
ΔV 75%~50% of Max Load		80	105	130	mV
Settling Time		0.04	0.08	0.12	ms

5. GENERAL SPECIFICATIONS

PARAMETER	DESCRIPTION	MIN	TYP	MAX	UNIT
Efficiency	Vin = 24 V, Iout = 3 A	-	77	-	%
	Vin = 48 V, Iout = 3 A	-	78	-	%
	Vin = 72 V, Iout = 3 A	-	78	-	%
	Vin = 96 V, Iout = 3 A	-	78	-	%
	Vin = 110 V, Iout = 3 A	-	80	-	%
Switching Frequency	1st stage	-	150	-	kHz
	2nd stage	-	250	-	kHz
Over Temperature Protection	Hot spot temperature.	-	125	-	°C
Over Voltage Protection(Static)			6	-	V
FIT	Calculated Per IEC 62380 TR 1(UTEC 80-810)	-	160.61	-	-
MTBF	(Vin = 24 V, Vo = 5 V, Io = 3 A, 0 LFM, Tac = 50°C, Tae = 35°C)	-	6.23	-	Mhrs
Isolation Voltage	Hot spot temperature.	-	-	2250	V
Weight		-	29	-	g
Dimensions (L × W × H)			2.30 × 1.1 × 0.425		inch
			58.42 × 27.94 × 10.8		mm

6. EFFICIENCY DATA

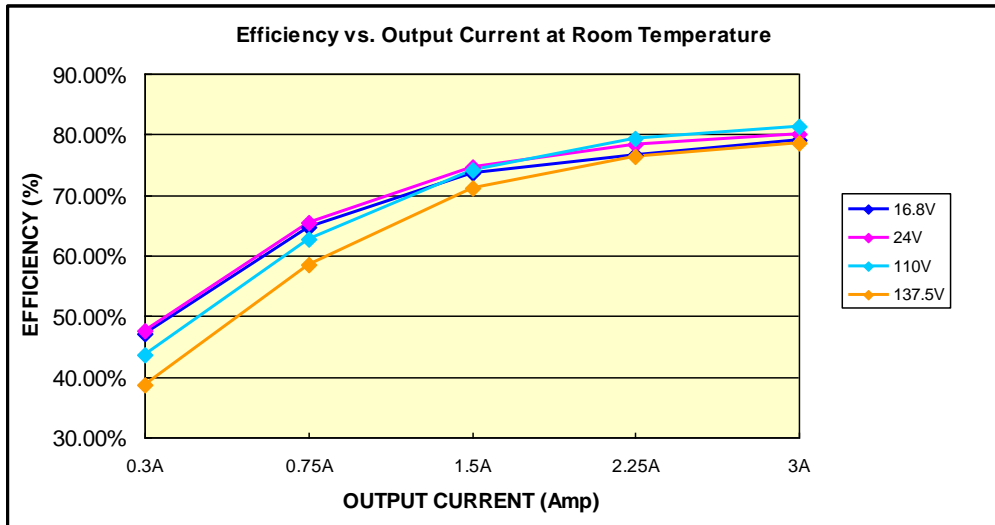

Figure 1. Efficiency data

7. REMOTE ON/OFF

PARAMETER	DESCRIPTION	MIN	TYP	MAX	UNIT
Signal Low (Unit On)	Active Low If Remote On/Off pin is open, the module is off.	-0.3	-	0.8	V
Signal High (Unit Off)		2.4	-	15	V
Current Sink		0	-	1	mA

Recommended remote on/off circuit for active low

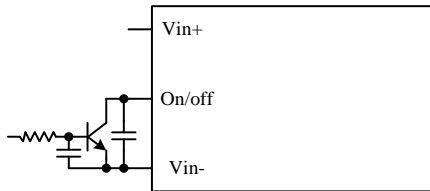

Figure 2. Control with open collector/drain circuit

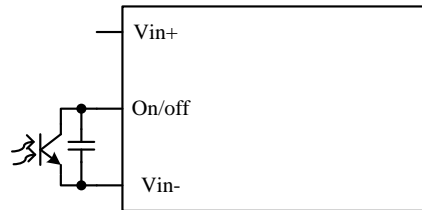

Figure 3. Control with photocoupler circuit

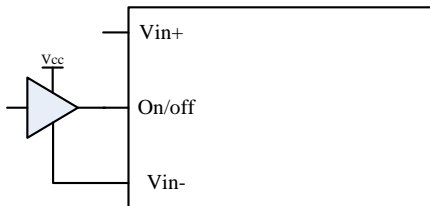

Figure 4. Control with logic circuit

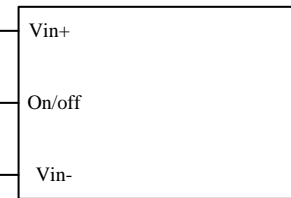

Figure 5. Permanently on

8. INPUT NOISE

Input reflected ripple current

Testing set up

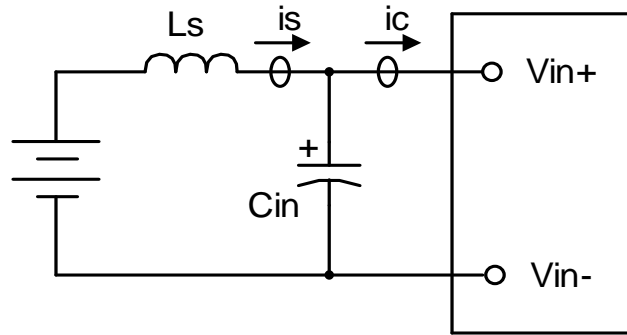

Figure 6.

Notes and values in testing.

is: Input Reflected Ripple Current

ic: Input Terminal Ripple Current

Ls: Simulated Source Impedance (10 μ H)

Cin: Electrolytic capacitor, should be as closed as possible to the power module to damped ic ripple current and enhance stability. Recommendation: 2* 100 μ F, ESR < 0.5 R @ 100 kHz, 20°C

Below measured waveforms are based on above simulated and recommended inductance and capacitance.

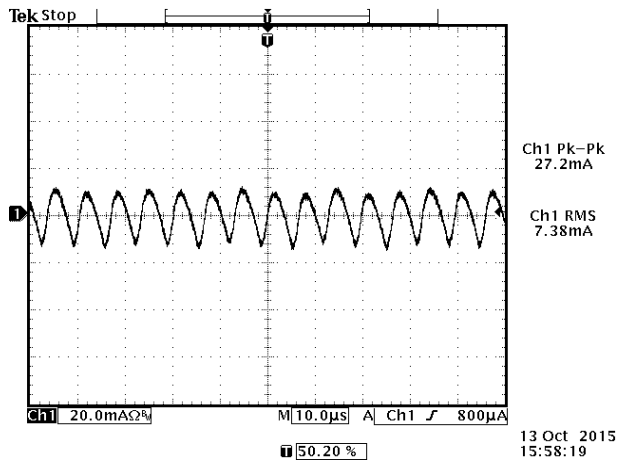

Figure 7. *is* (input reflected ripple current), AC component

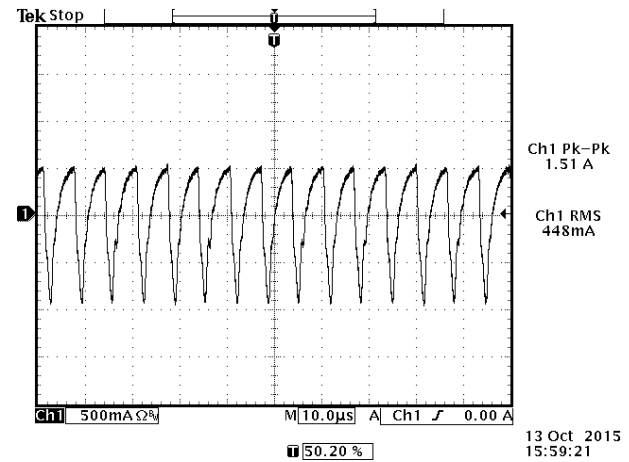

Figure 8. *ic* (input terminal ripple current), AC component

Test condition: 24 VDC input, 5 VDC / 3 A output and $T_a = 25^\circ\text{C}$, with 100 μ F ceramic capacitor and 100 μ F AL. cap at output.

9. RIPPLE AND NOISE WAVEFORM

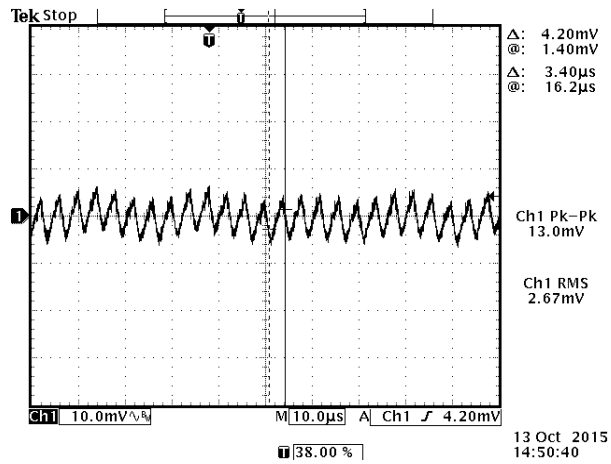

Figure 9. Ripple and noise, 24 VDC input, 5 VDC / 3 A output, $T_a = 25\text{ }^\circ\text{C}$, with 100 μF ceramic capacitor and 100 μF AL. cap at output.

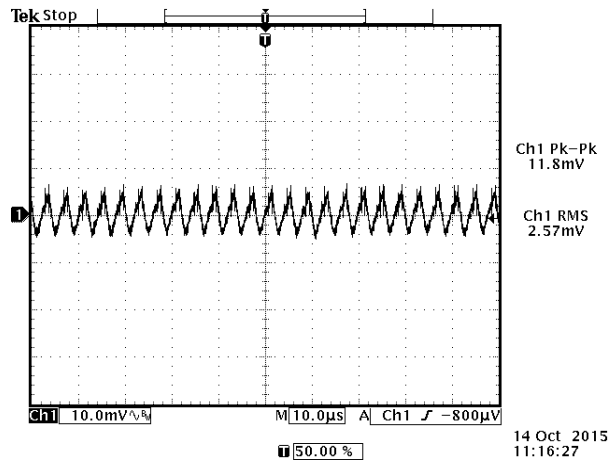

Figure 10. Ripple and noise, 110 VDC input, 5 VDC / 3 A output, $T_a = 25\text{ }^\circ\text{C}$, with 100 μF ceramic capacitor and 100 μF AL. cap at output.

10. TRANSIENT RESPONSE WAVEFORMS

$di/dt = 0.1 \text{ A}/\mu\text{s}$, with a $100 \mu\text{F}$ ceramic capacitor and a $100 \mu\text{F}$ electrolytic capacitors near the brick output.

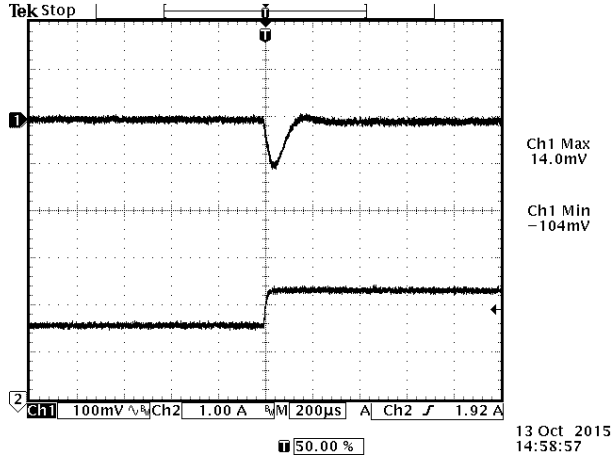

Figure 11. 50%-75% Load Transients at $V_{in} = 24 \text{ V}$ @ $T_a = 25^\circ\text{C}$

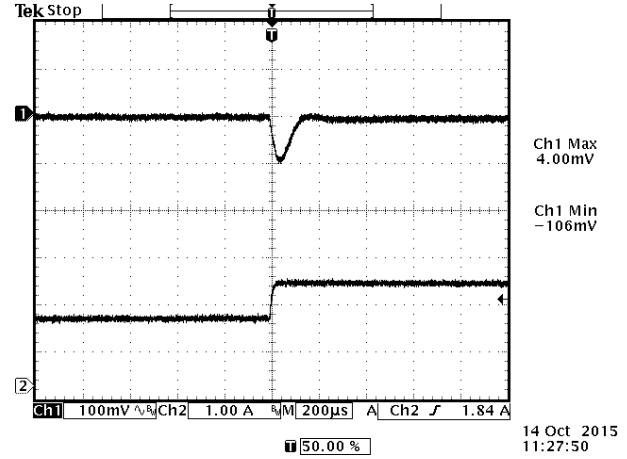

Figure 12. 50%-75% Load Transients at $V_{in} = 110 \text{ V}$ @ $T_a = 25^\circ\text{C}$

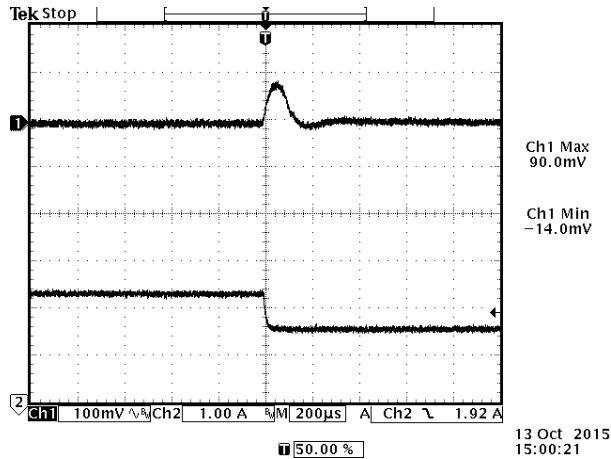

Figure 13. 75%-50% Load Transients at $V_{in} = 24 \text{ V}$ @ $T_a = 25^\circ\text{C}$

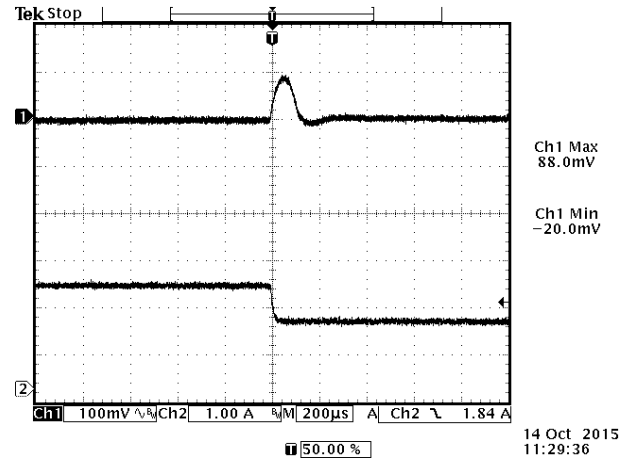

Figure 14. 75%-50% Load Transients at $V_{in} = 110 \text{ V}$ @ $T_a = 25^\circ\text{C}$

11. STARTUP & SHUTDOWN

di/dt = 0.1 A/μs, with a 100 μF ceramic capacitor and a 100 μF electrolytic capacitors near the brick output.

Rise time

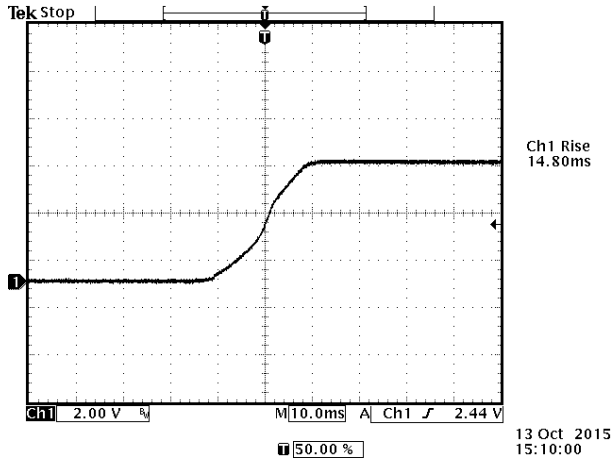

Figure 15. Test Condition: Vin = 24 V, Io = 3 A, Vo = 5 V

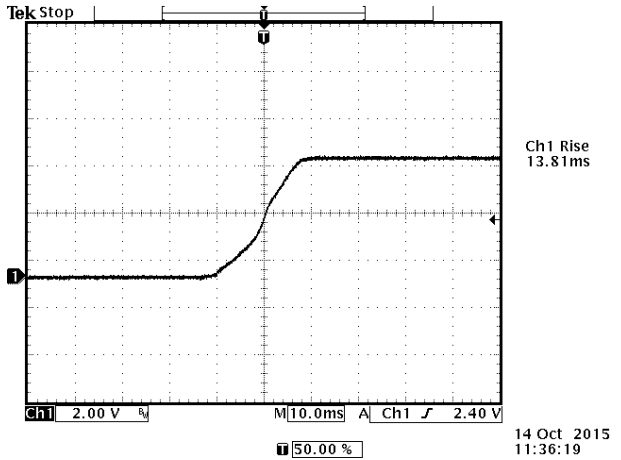

Figure 16. Test Condition: Vin = 110 V, Io = 3 A, Vo = 5 V

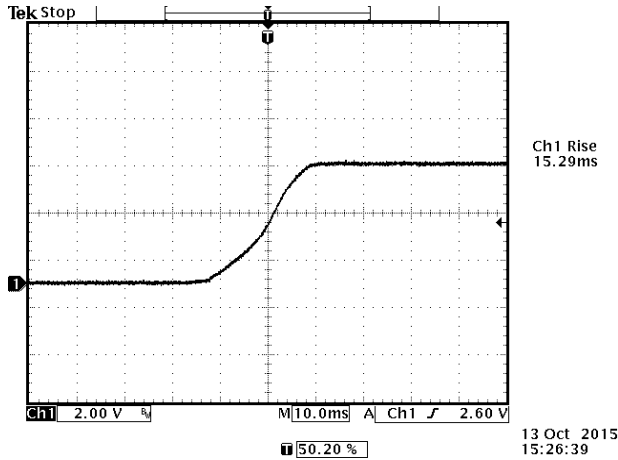

Figure 17. Test Condition: Vin = 24 V, Io = 3 A, Vo = 5 V, with Cext = 880 μF

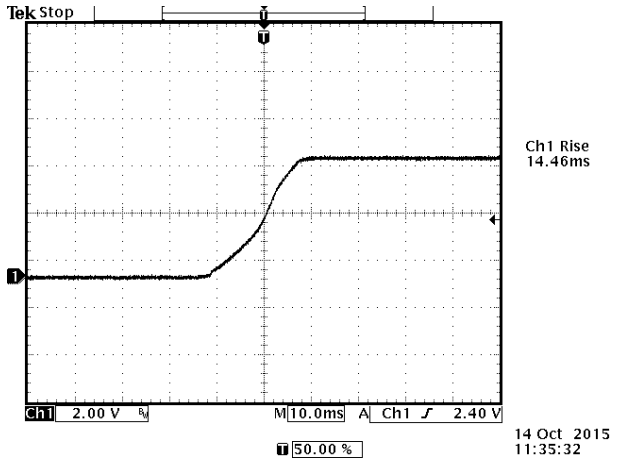

Figure 18. Test Condition: Vin = 110 V, Io = 3 A, Vo = 5 V, with Cext = 880 μF

Turn on delay time

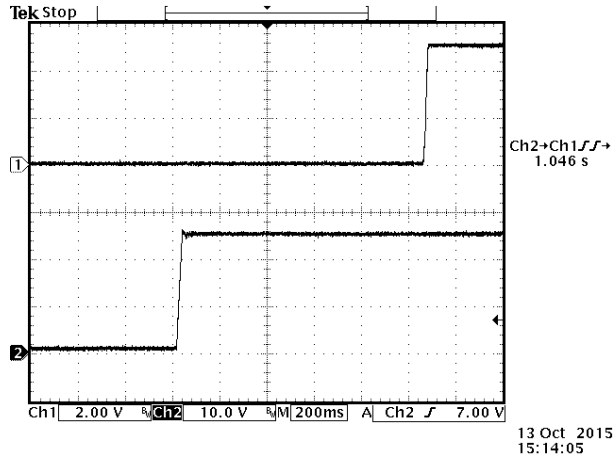

Figure 19. Startup from Vin

Ch1: Vo
Ch2: Vin

Test Condition: Vin = 24 V, Io = 3 A, Vo = 5 V

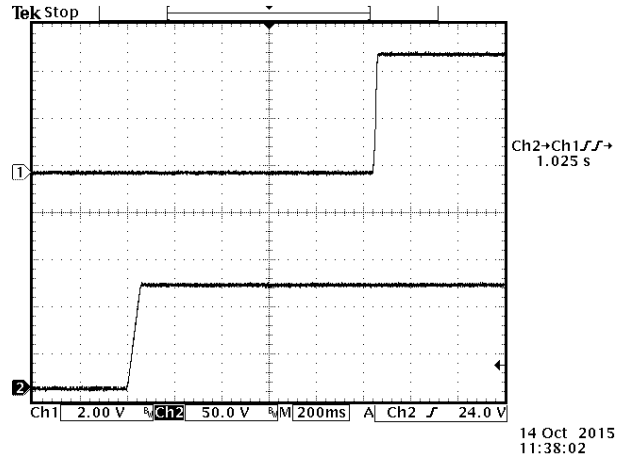

Figure 20. Startup from Vin

Ch1: Vo
Ch2: Vin

Test Condition: Vin = 110 V, Io = 3 A, Vo = 5 V

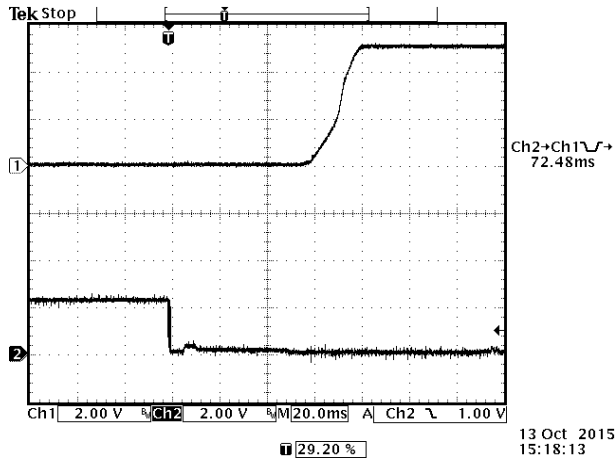

Figure 21. Startup from on/off

Ch1: Vo
Ch2: on/off

Test Condition: Vin = 24 V, Io = 3 A, Vo = 5 V

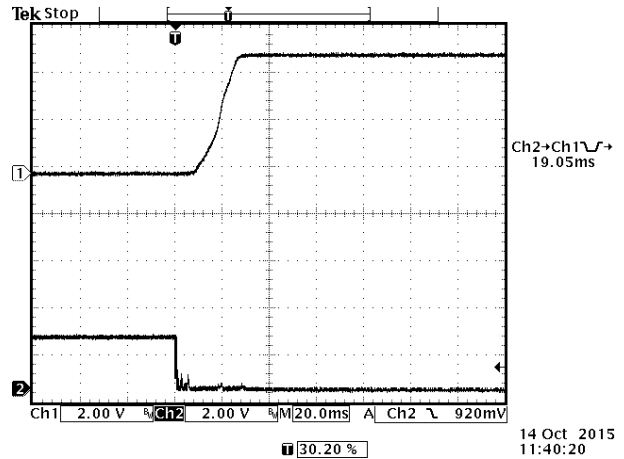

Figure 22. Startup from on/off

Ch1: Vo
Ch2: on/off

Test Condition: Vin = 110 V, Io = 3 A, Vo = 5 V

Shutdown

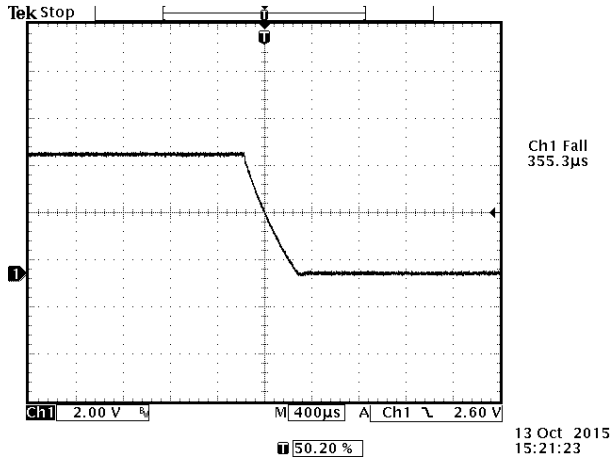

Figure 23. Test Condition: $V_{in} = 24\text{ V}$, $I_o = 3\text{ A}$, $V_o = 5\text{ V}$

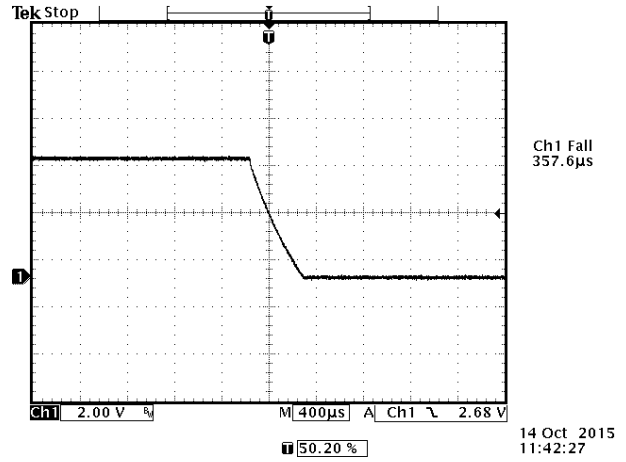

Figure 24. Test Condition: $V_{in} = 110\text{ V}$, $I_o = 3\text{ A}$, $V_o = 5\text{ V}$

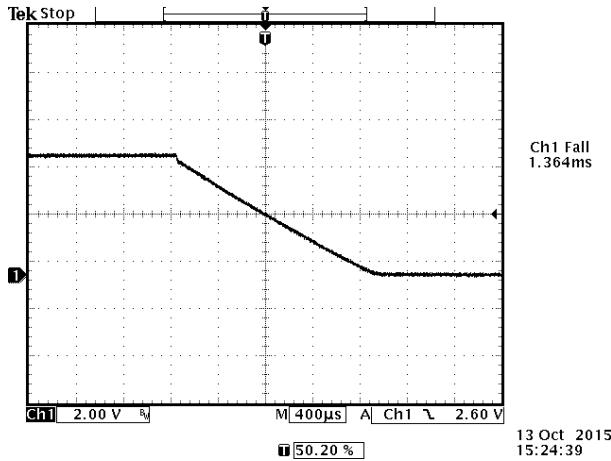

Figure 25. Test Condition: $V_{in} = 24\text{ V}$, $I_o = 3\text{ A}$, $V_o = 5\text{ V}$ with $C_{ext} = 880\text{ }\mu\text{F}$

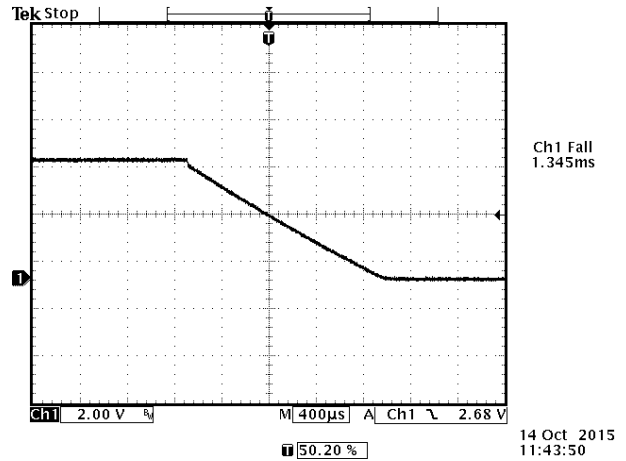

Figure 26. Test Condition: $V_{in} = 110\text{ V}$, $I_o = 3\text{ A}$, $V_o = 5\text{ V}$ with $C_{ext} = 880\text{ }\mu\text{F}$

12. HOLD UP CIRCUIT

PARAMETER	Notes	Symbol	MIN	TYP	MAX	UNITS
Hold up capacitor	Working voltage rating should be 200 V. Caution: This capacitor is necessary for both normal and hold up operation.	C_HOLD	100	-	330	μF
Hold up voltage	Normal operation.	V_HOLD	55	98	154	V
Hold up time	16.8 - 137.5 V input and all output range.	T_HOLD	12	-	-	ms

Recommended external hold up circuit

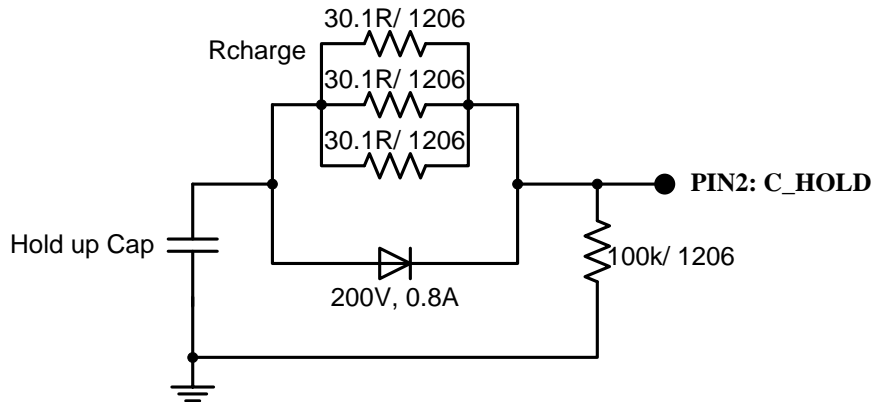

Figure 27.

Note: Three 1206 resistors are recommended for Rcharge for power dissipation consideration.

13. THERMAL DERATING CURVE

Hot spot location and allowed maximum temperature

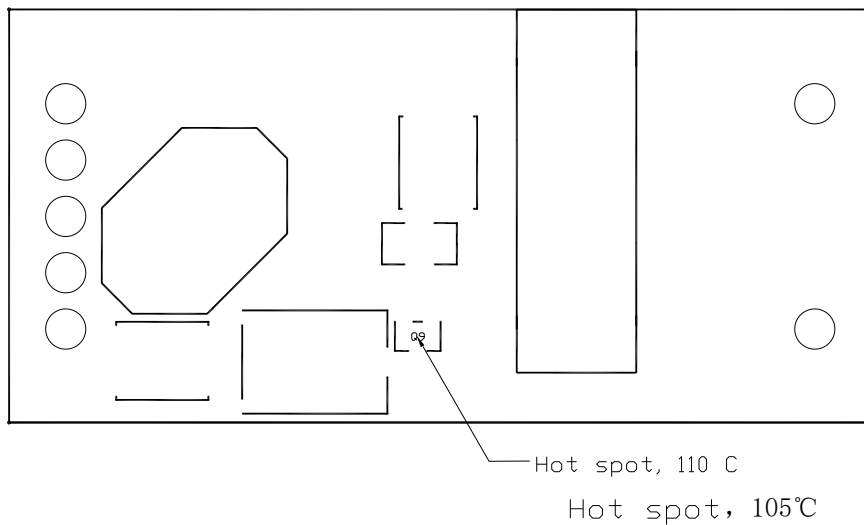

Figure 28. Module top view

Derating curve under normal input

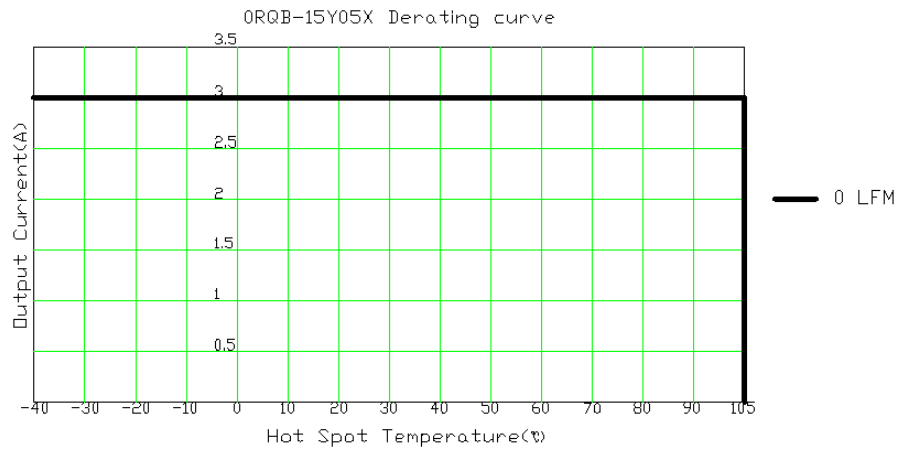

Figure 29. Derating curve
 Vin=24V, 48V, 72V, 96V, 110V

14. SAFETY

TUV certificated to EN 60950-1

TUV certificated to EN 62368-1

CE certificated to Low Voltage Directive 2014/35/EU



Asia-Pacific
 +86 755 298 85888

Europe, Middle East
 +353 61 225 977

North America
 +1 408 785 5200

15. MECHANICAL DIMENSIONS

OUTLINE

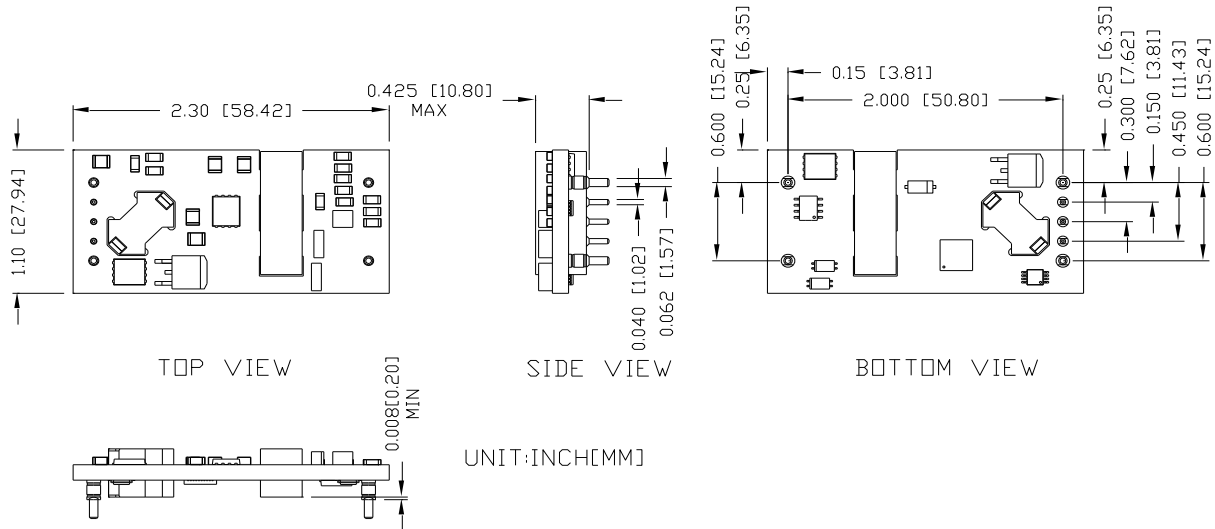

Figure 30. Outline

Note: This module is recommended and compatible with Pb-Free Wave Soldering and must be soldered using a peak solder temperature of no more than 260 °C for less than 5 seconds.

Notes:

- 1) All Pins: Material - Copper Alloy;
Finish - Tin plated.
- 2) Un-dimensioned components are shown for visual reference only.
- 3) All dimensions in inches; Tolerances: x.xx +/-0.02 in [0.5 mm]. x.xxx +/-0.010 in [0.25 mm]. Unless otherwise stated.

PIN DEFINITIONS

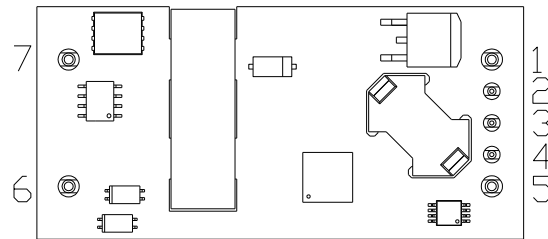

BOTTOM VIEW

Figure 31. Pins

PIN	FUNCTION	PIN	FUNCTION
1	Vin(+)	5	Vin(-)
2	C_HOLD	6	Vout(-)
3	ON/OFF	7	Vout(+)
4	V_AUX(5V)		

RECOMMENDED PAD LAYOUT

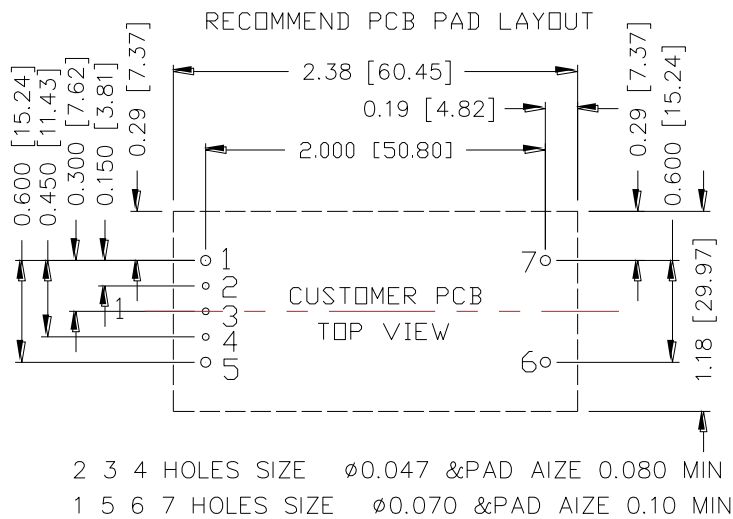

Figure 32. Recommended pad layout

16. REVISION HISTORY

DATE	REVISION	CHANGES DETAIL	APPROVAL
2014-04-14	A	First release	J.Yan
2014-07-23	B	Update hold up capacitor, Update Input spec	J.Yan
2014-10-17	C	Update Input spec, hold up circuit spec, frequency, start up spec, TD spec, output capacitor spec, efficiency curve.	J.Yan
2014-12-24	D	Update No Load Input Current (note), turn on time, hold up circuit, mechanical design.	J.Yan
2015-07-27	E	Update MD.	J.Yan
2015-10-15	F	Update Input Reflected Ripple Current, Load Regulation, Regulation Over Temperature, Output DC Current Limit, Transient Response, MTBF, Dimensions. Add input noise, output noise, transient, start up figures.	J.Yan
2016-02-26	G	Update Operating Temperature, Thermal resistance and Hot spot location graph.	J.Yan
2016-04-21	H	Update Safety Certification, MTBF, Thermal Derating Curve.	J.Yan
2016-10-14	I	Update Altitude	J.Yan
2018-03-26	AJ	Add Operating Input Voltage range 3	J.Yao
2019-10-24	AK	Add feature reinforced isolation	J.Yao
2021-04-29	AL	Add object ID. Update safety certificate.	J.Yao

For more information on these products consult: tech.support@psbel.com

NUCLEAR AND MEDICAL APPLICATIONS - Products are not designed or intended for use as critical components in life support systems, equipment used in hazardous environments, or nuclear control systems.

TECHNICAL REVISIONS - The appearance of products, including safety agency certifications pictured on labels, may change depending on the date manufactured. Specifications are subject to change without notice.



tech.support@psbel.com
belfuse.com/power-solutions