

TEC3200-12-074xA

AC/DC-DC CRPS Front-End Power Supply

TEC3200-12-074xA is a 3200 W active power factor corrected CRPS switching power supply that converts standard AC mains power or High Voltage DC bus voltages (HVDC) into a main output of 12 VDC for powering systems using distributed power architectures.

The power supply is hot-swappable and supports N+1 redundant architecture. The high-power density helps to improve the overall system efficiency and enhance system reliability. The full digital control facilitates remote set-up, monitoring and control.

TEC3200-12-074xA offers multiple protections including overvoltage, overtemperature, overcurrent, overpower & short circuit protection.

This power supply meets international safety standards and displays the CE-Mark for the European Low Voltage Directive (LVD).



Key Features & Benefits

- 80 PLUS Titanium Efficiency
- Input Voltage Ranges:
 - 90 – 140 VAC (1300 W)
 - 180 – 219 VAC (3000 W)
 - 220 – 264 VAC (3200 W)
 - 180 – 219 VDC (3000 W)
 - 220 – 320 VDC (3200 W)
- Nominal Output Voltage 12.2 VDC
- Standby Output 12.2 V_{SB}
- Output Power up to 3200 W
- Active Power Factor Correction (PFC)
- Intel Standard CRPS Form Factor
- High Power Density
- Dimensions: 185 x 73.5 x 40 mm (7.28 x 2.89 x 1.57 in)
- UL/CSA 62368-1, EN/IEC 62368-1 Certified (Pending Approval)
- Supports N+1 Redundancy, Cold Redundancy, Internal ORing
- Black Box Recorder, Bootloader
- Clockwise and Counter-Clockwise Fan Rotation
- Supports Power Management Bus Communication Protocol

Applications

- Networking Switches
- Servers & Routers
- Telecommunications

1 ORDERING INFORMATION

TEC	3200	-	12	-	074	x	A
Product Family	Power Level	Dash	V1 Output	Dash	Width	Airflow	Input
TEC Front-Ends	3200 W		12 V		73.5 mm	N: Normal R: Reverse	A: AC

2 INPUT

PARAMETER	DESCRIPTION / CONDITION	MIN	NOM	MAX	UNIT
Input Voltage *	Low Line V _{IN} (1300 W)	90	100-127	140	VAC _{RMS}
	Low Line V _{BROWN_IN}	80	84	88	VAC _{RMS}
	Low Line V _{BROWN_OUT}	70	74	79	VAC _{RMS}
	High Line V _{IN} (3200 W)	220	220-240	264	VAC _{RMS}
	High Line V _{IN} (3000 W)	180	200-219	219	VAC _{RMS}
	High Line V _{BROWN_IN}	171	175	179	VAC _{RMS}
	High Line V _{BROWN_OUT}	159	164	169	VAC _{RMS}
	High Line V _{IN} (3200 W)	220	220-320	320	VDC
	High Line V _{IN} (3000 W)	180	200-219	219	VDC
	High Line V _{BROWN_IN}	167	171	175	VDC
High Line V _{BROWN_OUT}	155	160	165	VDC	
AC Input Frequency		47	50/60	63	Hz
Over Voltage Protection V _{IN_OVP}	AC Input	285	290	295	VAC _{RMS}
	DC Input	335	340	345	VDC
Input Current	High Line nominal (AC)			16.0	A
	Low Line nominal (AC)			16.0	A
	Nominal voltage (DC)			16.0	A
Inrush Current	For 240 VAC / 240 VDC @ 1 – 1200 ms cold start, 3200 W			35	A _{peak}
Leakage Current	@ 264 VAC, 63 Hz			875	µA
Power Factor	230/208/240 VAC / 50/60 Hz, 10% load	0.90			
	230/208/240 VAC / 50/60 Hz, 20% load	0.96			
	230/208/240 VAC / 50/60 Hz, 50% load	0.98			
	230/208/240 VAC / 50/60 Hz, 100% load	0.99			
Current iTHD (Total Harmonic Distortion)	200 – 240 VAC / 50/60 Hz, >5% & <10% load			20	
	200 – 240 VAC / 50/60 Hz, >10% & <20% load			15	
	200 – 240 VAC / 50/60 Hz, ≥ 20 % load			10	%
	200 – 240 VAC / 50/60 Hz, ≥ 40 % load			8	
	200 – 240 VAC / 50/60 Hz, ≥ 50% load			5	
Efficiency	230 VAC / 60 Hz, 10% load	90			%
	230 VAC / 60 Hz, 20% load	94			%
	230 VAC / 60 Hz, 50% load	96			%
	230 VAC / 60 Hz, 100% load	94			%
AC Line Dropout / Hold-up Time	@ 20% of rated load, 3200 W	40			
	@ 50% of rated load, 3200 W	15			
	@ 90% of rated load, 3200 W	10			ms
	@ 100% of rated load, 3200 W	9			
AC Line 12V _{SB} Hold-up Time	@ 100% load	70			ms
AC Line Sag	0 to 1/2 AC cycle (nom AC voltage ranges, 50/60 Hz) No loss of function or performance. (< 70% load)		95		%
	> 1 AC cycle (nom AC voltage ranges, 50/60 Hz) Loss of function acceptable, self-recoverable	30			%
AC Line Surge	Continuous (nom AC voltage ranges, 50/60 Hz) No loss of function or performance		10		%
	0 to 1/2 AC cycle (mid-point of nom VAC ranges, 50/60 Hz) No loss of function or performance		30		%
AC Line Isolation	Primary to secondary, compliant with dielectric strength criteria	3000			VAC
		4242			VDC
Insulation	Reinforced insulation compliant with IEC 950				

Notes:

- 1: The standby output may continue to operate when input voltage below V_{brown_out} range.
- 2: Brown-in / Brown-Out can be used 100% of rated load only above 1V/S variation of input voltage, otherwise should become 80% of rated load for low slope of V_{in} .
- 3: The I_{in} is specified when the V_{in} at nominal condition.
- 4: The AC voltage considering $CF=1.1, 1.6$ should meet the turn on/off point as above. Due to many waveforms have same C.F result, so the all C.F setting in this specification is based on Chroma instrument setting.
- 5: Either of Line or Neutral could be the positive polarity of 240Vdc application.
- 6: The power supply shall not be damaged when the input voltage is in the range of 265VAC~300VAC for a long time.

3 OUTPUT

PARAMETER	DESCRIPTION / CONDITION	MIN	NOM	MAX	UNIT
Output Voltage			12.2		VDC
Max Continuous Output Power				3200	W
Output Current	1300 W 3000 W 3200 W	0		106.6 246.0 262.3	A
Turn on/off Overshoot & Undershoot	Regulation band within 20 ms Undershoot during turn-off, @ V_{nom}			10 10	%
Transient Load	Δ Step Load Size, 60% of Load Max, 2200 μ F x2			2.5	A/ μ s
Capacitive Loading		2200		70000	μ F
Output Ripple & Noise	20 MHz BW; 2200 μ F			120	mV _{PK-PK}
+12 V_{SB} OUTPUT					
+12 V _{SB} Output Voltage	Voltage Regulation Limit \pm 6 %		+ 12.2		V _{SB}
+12 V _{SB} Output Current		0		3	A
Transient Load	Δ Step Load Size = 1 A, 1000 μ F			0.5	A/ μ s
Capacitive Loading		100		3100	μ F
Output Ripple & Noise	20 MHz BW, 270 μ F			120	mV _{PK-PK}

3.1 OUTPUT LOAD & STATUS REGULATION

Output	Power (W)	Max Current Rating (A)	Peak Current			Voltage Regulation
			20 s	10 ms	100 μ s	
12 V _{OUT}	90 – 140 VAC	1300				Static: 11.8 to 12.6 V
	180 – 219 VAC 180 – 219 VDC	3000				
	220 – 264 VAC 220 – 320 VDC	3200				Dynamic: 11.6 to 12.8 V
				Rated + 10 A	Rated + 72 A	
12 V _{SB} ¹	–	3	3.3 A	NA	NA	12.20 V \pm 5%

¹ Length of time peak power can be supported is based on thermal sensor and assertion of the SMBAlert# signal. Minimum peak power duration shall be 20 s without asserting the SMBAlert# signal. The peak load requirement should apply to full operating temperature range.

² The setting of $I_{Peak} < I_{OCW} < I_{OCP}$ needs to be followed to make the CLST work reasonably.

³ Power supply must protect itself in case system doesn't take any action to reduce load based on SMBAlert# signal asserting.

⁴ The power supply shall support 10 ms peak power at 20% duty cycle step loading for an average current at the current rating.

⁵ After Peak Current condition, load current should dwell @ full load condition about 10 Minutes before the next Peak current occurred.

⁶ C20 Inlet current de-rating may exceed during low line Peak Current condition.



3.2 LOAD SHARE SIGNAL CHARACTERISTICS

ITEM	DESCRIPTION	MIN	NOM	MAX
$V_{SHARE}; I_{OUT}=Max$	Voltage of load share bus at specified maximum output current	7.76 V	8.0 V	8.24 V
$\Delta V_{SHARE} / \Delta I_{OUT}; I_{OUT} > 1A$	Slope of load share bus voltage with changing load	8.00 / I_{MAX} V/A		
I_{SHARE} sink; $V_{SHARE} = 4.00V$	Amount of current the load share bus output from each power supply sources.	0.5 mA		
I_{SHARE} SOURCE $V_{SHARE} = 4.00V$	Amount of current the load share bus output from each power supply sinks.	4 mA		

4 PROTECTION

4.1 OVER CURRENT & OVER POWER PROTECTION (OCP & OPP)

The power supply has a current limit to prevent the outputs from exceeding the values shown in table below. If the current limits are exceeded the power supply shuts down. The power supply will not be damaged from repeated power cycling in this condition.

V_{in}	PARAMETER	DESCRIPTION	THRESHOLDS		TIMING	
			MIN	MAX	MIN	MAX
180~264VAC	OPP/Fast OCP ^{1,4}	Overpower protection	Rating + 82 A	Rating + 92 A	1 ms	3 ms
	Slow OCP	Slow overcurrent protection	Rating + 20 A	Rating + 30 A	20 ms	300 ms
	Fast OCW ²	Fast over current warning (SMBAlert#)	Rating + 72 A	Rating + 82 A	500 us	1 ms
	Slow OCW ³	Slow over current warning (SMBAlert#)	Rating + 10 A	Rating + 20 A	10 ms	300 ms
	OCPstby	Stby overcurrent protection	3.5 A	5.0 A	1 ms	100 ms
90~140VAC	OPP/Fast OCP ^{1,4}	Over power protection	Rating + 82 A	Rating + 92 A	1 ms	3 ms
	Slow OCP	Slow overcurrent protection	Rating + 16 A	Rating + 24 A	20 ms	300 ms
	Fast OCW ²	Fast overcurrent warning (SMBAlert#)	Rating + 72 A	Rating + 82 A	500 us	1 ms
	Slow OCW ³	Slow over current warning (SMBAlert#)	Rating + 10 A	Rating + 16 A	10 ms	300 ms
	OCPstby	Stby overcurrent protection	3.5 A	5.0 A	1 ms	100 ms

Notes:

¹ Over power protection mode shall be held for at least 100 μ s before OCP shuts down the PSU.

² Fast OCW threshold must be set below the OPP / Fast OCP threshold. Fast OCW shall hold the SMBAlert# signal asserted for 50 ms to 150 ms; then de-assert.

³ Slow OCW threshold must be set below the Slow OCP threshold.

⁴ OPP feature is not needed if fast V-mode is present and enabled in the platform. Instead the PSU shall use this threshold as an Over Current Protection level and shutdown to protect itself.

4.2 OVER & UNDER VOLTAGE PROTECTION (OVP)

OUTPUTS	UNDER VOLTAGE		OVER VOLTAGE		PROTECTION MODE	UNIT
	MIN	MAX	MIN	MAX		
12 V_{OUT}	10.0	10.9	13.5	15.0	Latch-off	V
V_{SB}	10.0	10.9	13.5	15.0	Recovery	V

4.3 OVER TEMPERATURE PROTECTION (OTP)

The power supply will be protected against over temperature conditions caused by loss of fan cooling or excessive ambient temperature. In an OTP condition the PSU will shut down. When the power supply temperature drops to within specified limits, the power supply shall restore power automatically.

The OTP circuit must have built in hysteresis such that the power supply will not oscillate on and off due to temperature recovering condition. The OTP trip level shall have a minimum of 5 °C of ambient temperature hysteresis.

	TRIGGER POINT	TOLERANCE
Over Temp. warning (OTW)	62 °C	3 °C
Over Temp. Protection (OTP)	65 °C	3 °C

4.4 SHORT CIRCUIT PROTECTION (SCP)

A short circuit is considered to be resistance of 50 mΩ or less, applied to any output during start-up or while running will not cause any damage to the power supply (connectors, components, PCB traces, etc.).

The power supply shuts down and latches off for short on main outputs but recovers upon PSON# toggled or AC re-applied. When the Standby output V_{SB} is shorted the output may go into “hiccup mode”, and all outputs shuts down upon a short circuit of the V_{SB} . When the short is removed on V_{SB} , the power supply shall recover automatically.

4.5 RESET AFTER SHUTDOWN

If the power supply latches into a shutdown state due to a fault condition on any output, the power supply will return to normal operation only after the fault has been removed and the power supply has been power- cycled. Both methods of resetting the power supply shall be designed into the supply so that the user may choose which method to use.

Reset can be accomplished in one of two ways as below:

- Removing AC input power for 10 sec or toggling PSON# signal shall be able to reset the latch off protection.
- Cycling the state of PSON# from on to off to on. The minimum cycle time will be 100 ms.

5 SIGNALS

The below table is a TTL signals summary, which presents all the pull-high resistance and pull-up location.

The ripple voltage for all TTL signals shall be less than 250 mV @ B.W = 20 MHz

PIN NO.	PIN NAME	PIN TYPE (I/O/A)	ACTIVE	PULL-UP RES. OF PSU (kΩ)	PULL-UP VOL. (V)
A19	SDA	I / O	--	10k/0603	3.3
A20	SCL	I / O	--	10k/0603	3.3
A21	PSON#	I	Low	3.48	3.3
A22	SMBAlert#	O	Low	8.2	< 5
A25	PWOK	O	High	0.02	3.3
B19	A0	I	--	10	3.3
B20	A1	I	--	10	3.3
B22	Cold Redundant Bus	I / O	High	--	--
B23	12V _{OUT} Load Share Bus	A	--	--	--
B24	PRESENT#	Input	Low	0.1	GND
B25	Vin_GOOD#	O	High	1	3.3

5.1 PSON#

The PSON# signal is required to remotely turn on/off the power supply. PSON# is an active low signal that turn on the main power rails. When this signal is not pulled low by the system, or left open, the outputs turn off.

The power supply provides an internal pull-up resistor to high. The power supply also provides de-bounce circuitry on PSON# to prevent it from oscillating On/Off at startup when activated by mechanical switch. Provisions for de-bouncing will be included in the PSON# circuitry to prevent the power supply from oscillating on/off at startup.



SIGNAL TYPE	PULL-UP TO INTERNAL V _{CC} LOCATED IN POWER SUPPLY	
PSON# =Low	PSU ON	
PSON# = Open or High	PSU OFF	
	MIN	MAX
Logic level low (PSU ON)	0 V	1 V
Logic level high (PSU OFF)	2.0 V	3.46 V
Sink current, V _{PSON#} = low	4 mA	

5.2 POWER GOOD (PWOK or P_GOOD)

This signal should be asserted high by the power supply to indicate that all outputs are within the regulation thresholds. This signal should be de-asserted to a low state when any of the DC outputs voltage falls below its under voltage threshold, or when mains power has been removed for a time sufficiently long so that power supply operation can't be guaranteed.

This signal will have an internal pull-up resistor to internal 3.3 V sources.

SIGNAL TYPE	PULL-UP TO V _{SB} LOCATED IN THE POWER SUPPLY	
PWOK or P_Good = High	DC Outputs O.K.	
PWOK or P_Good = Low	DC Outputs N.G.	
	MIN	MAX
Logical Level Low, I _{SINK} = 400uA	0 V	0.4 V
Logical Level High, I _{SOURCE} = 500uA	2.4 V	3.46 V
Sink current, PWOK = low	400 µA	
Source current, PWOK = high	500 µA	
PWOK delay: T _{PWOK_ON}	100 ms	500 ms
Power down delay: T _{PWOK_OFF}	1 ms	
PWOK or P_Good Rise & Fall Time	100 µs	

5.3 PRESENT#

This pin will be tied to Standby return through a resistor. System side should have a pull-up resistor which limits the max current 4mA to go through from this signal pin to the power supply, the pull-down resistor shall be 0 ohm with 1206/0805 package or short PRESENT# to ground directly.

5.4 LOAD SHARE SIGNAL

This input / output will allow two or more power supplies to share output current between them. If one of the supplies fails, the remaining supplies must pick up the entire load without any of the outputs dropping out of regulation. A defective supply that is connected to the output voltage bus will not have adverse effect on the operation of the remaining function supplies.

Total Load	Number of supplies	V _{LS} (V) Minimum	V _{LS} (V) Nominal	V _{LS} (V) Maximum
100%	2	3.8	4	4.2
50%	2	1.8	2	2.2
20%	2	0.64	0.8	0.96
100%	1	7.76	8	8.24
50%	1	3.8	4	4.2
20%	1	1.4	1.6	1.8
0%	1	0	0	0.3

5.5 SHARING ACCURACY

The 12 V main will have active load sharing. The failure of a power supply should not affect the load sharing or output voltages of the other supplies and does not cause these outputs to go out of regulation in the system.

SYSTEM LOAD	SHARING ACCURACY
100 – 50 %	± 4%
50 – 20 %	± 5%
20 – 10 %	± 10%

5.6 SMBAlert#

This signal indicates that the power supply is experiencing a problem that the user should investigate. This shall be asserted due to Critical events or Warning events. The signal will be activated, if critical component temperature reached a warning threshold such as OCV / OTW / OCP / OTP, SMB Alert trigger condition please refer FW Spec in detail.

This signal may also indicate the power supply is reaching its end of life or is operating in an environment exceeding the specified limits.

SIGNAL TYPE	PULL-UP TO 3.3 V _{SB} LOCATED IN PSU	
SMBAlert# = High	OK	
SMBAlert# = Low	Power Alert to system	
	MIN	MAX
Logical Level Low, I _{SINK} = 4 mA	0 V	0.4 V
Logical Level High, I _{SOURCE} = 50 μ A	2.4 V	3.46 V
Sink current, Alert# = low		4 mA
Source current, Alert# = high		50 μ A
Alert# fall time		100 μ s

5.7 ADDRESS_A0 / A1

This signal is defined by end user system for Power Management Bus communication, to allocate address of power supply unit in particular slot location. This signal has an internal resistor to internal 3.3 V located in power supply. The address of power supply unit must be set by user system for Power Management Bus communication reliability.

SIGNAL TYPE	PULL-UP TO INTERNAL 3.3 V _{SB} LOCATED IN POWER SUPPLY	
	MIN	MAX
Logical Level Low	0 V	0.4 V
Logical Level High	2.4 V	3.46 V

5.8 SCL & SDA

SCL is the SMBus clock input to the supply, SDA is the bi-directional SMBus data path to /from the supply. Both signals have a pull-up resistor to 3.3 V internal located in power supply. The pull-up must be diode isolated to prevent an unpowered/ faulted supply from loading the signal. It must be designed to not glitch bus during hot plug and unplugging. The Power Management Bus operation frequency is 100 kHz. It shall conform to SMBus V2.0 signaling protocol standards. And this specification is based on the Power Management Bus specification parts I and II, revision 1.2. The hardware setting in SDA and SCL is:

Inner Pulled up Resistor to internal 3.3V = 10k ohm / 0603.

Inner Filter MAX capacitor less than 68 pF.

Inner serial Resistor (Rs) = 10 ohm / 0603.



Note:

Once the internal communication between primary and second DSP/MCU fault is detected, the Fan speed will be run at full speed until the fault is removed

5.9 REMOTE SENSE + / REMOTE SENSE -

These signals are analog Input / Output 12V_{OUT} Main Voltage Sense. Both are analog input / output voltage sense lines to compensate for power path voltage drop. These low level analog signals should be isolated from digital circuit noise. When one or more remote sense lines are opened, regulation measured at the power supply output connector must be maintained within regulation defined, plus or minus an additional 200 mV but no more than 300 mV.

5.10 VIN_GOOD#

This signal is an output to indicate AC power is existence and is within operation range. It should act from high to low level within 4 ms only for Vin drops out to zero and input voltage brown-out events. The 4 ms timing is defined as Vin = 0 to VIN_GOOD# signal low level.

SIGNAL TYPE	PULL-UP 2K Ω TO INTERNAL 3.3 V _{SB} LOCATED IN POWER SUPPLY	
VIN_GOOD# = High	Input voltage is in operating range	
VIN_GOOD# = low	Input voltage is out of operating range	
	MIN	MAX
Logical Level Low, I _{SINK} = 4 mA	0 V	0.4 V
Logical Level High, I _{SOURCE} = 50 μ A	2.4 V	3.46 V
Sink current, VIN_GOOD# = low		4 mA
Source current, VIN_GOOD# = high		50 μ A
VIN_GOOD# rise and fall time		400 μ s

5.1 COLD REDUNDANT BUS

This signal should be connected together at system board for smart redundant function. Please refer to the Power Management Bus specification for detail.

5.2 STANDBY TURN-OFF

Following removal of AC power, the Standby output will remain at its steady state value until such time as it begins to decrease in voltage. The decrease will be monotonic in nature dropping to 0.5 V or less. There will be no other perturbations of this voltage at, or following, removal of AC power.

5.3 FAN SPEED CONTROL

The power supply has incorporated a 40 x 28 mm² fan for cooling the power supply when installed in the system. The airflow direction shall be from the card edge connector side to the AC inlet side of the power supply (DC->AC) or opposite direction (AC->DC). The Fan speed control has a close loop algorithm based on both the critical component temperature and the ambient temperature (Inlet temperature). Thus ensure the PSU Fan will always ramp to maximum speed under any condition to protect the power supply from overheating. These conditions include high ambient temperatures, loading, AC input, and airflow impedance.

Under any steady state operating condition (steady state power output level and steady state inlet air temperature), fan oscillation shall be controlled such that associated sound power level variation falls within roughly 10% mean speed. This condition may be treated as steady state fan speed condition. After the new load and/or cooling condition steady state is established, transition to the steady state fan speed shall take place within 60 s.

5.4 LED INDICATORS

The power supply has a single bi-colored LED (green & amber) for indication of the power supply status.

POWER SUPPLY CONDITION	LED STATE
12V _{OUT} is normal	GREEN
No AC power to all power supplies	OFF
AC present / Only V _{SB} on (PS off)	1 Hz Blink GREEN
Slave PSU is set as active standby mode (Cold Redundant)	1 Hz Blink GREEN
AC cord unplugged or AC power lost; with a second power supply in parallel still with AC input power.	AMBER
Power supply critical event causing a shutdown; failure, OCP, SCP, OVP, Fan Fail and OTP	AMBER
Power supply warning events where the power supply continues to operate; high temp, high power, high current and slow FAN.	1 Hz Blink AMBER
Power supply FW updating	2 Hz Blink GREEN

5.5 TIMING

These are the timing requirements for the power supply operation. All outputs must rise monotonically. Table below shows the timing requirements for the power supply being turned on and off via the AC input, with PSON# held low and the PSON# signal, with the AC input applied.

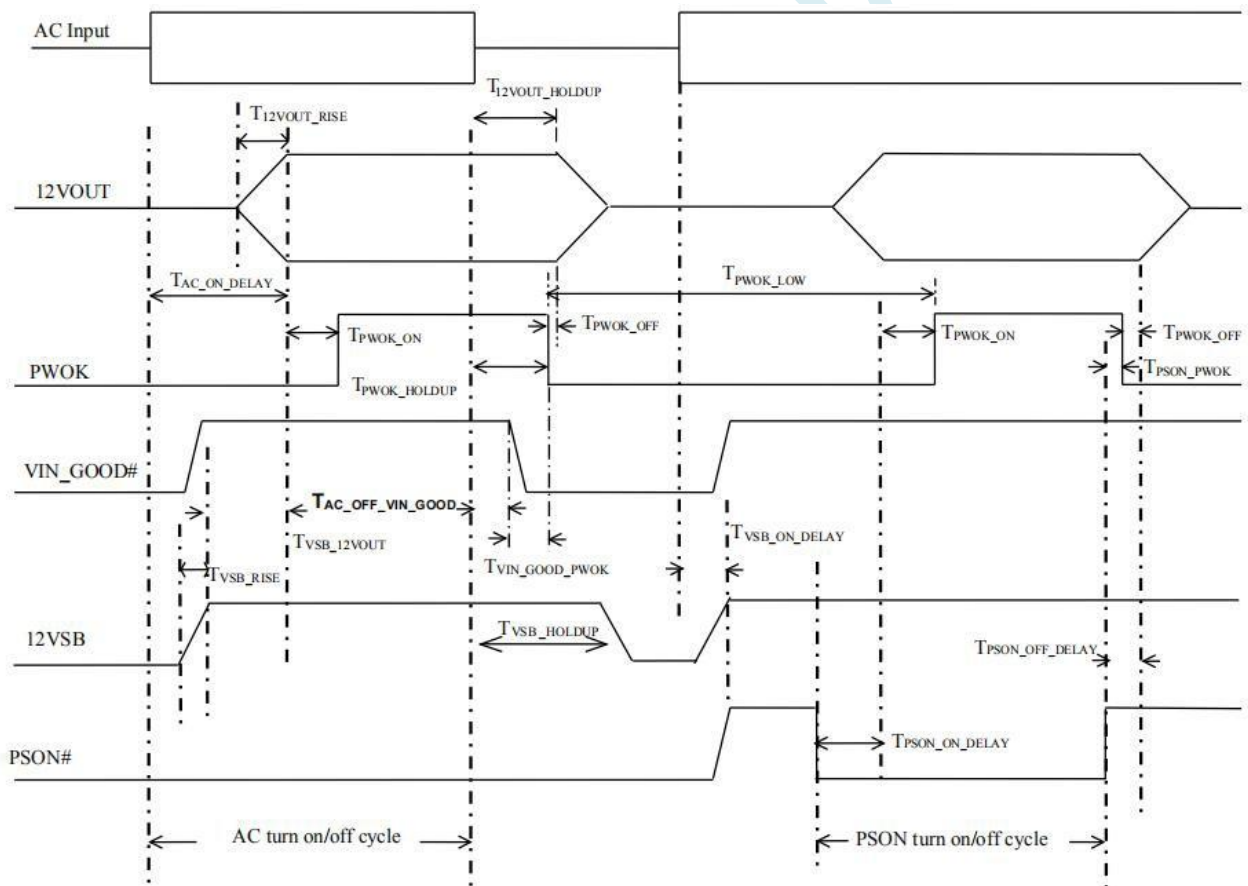

Figure 1. Signal Timing Sequence



ITEM	DESCRIPTION	MIN	MAX	UNITS
T _{AC_OFF_VIN_GOOD}	The time interval between AC Drop to zero to VIN_GOOD# signal gets asserted	--	4	ms
T _{Vin_good_PWOK}	VIN_GOOD# shall be get asserted 1ms prior to PWOK during ac loss event.	1	--	ms
T _{VSB_RISE}	Standby voltage rise time for V _{SB}	5	50	ms
T _{VSB_ON_DELAY}	Delay from AC being applied to 12V _{SB} being within regulation.	--	1500	ms
T _{12VOUT_RISE}	Output voltage rises time for 12V _{OUT}	5	50	ms
T _{AC_ON_DELAY}	Delay from AC being applied to 12V _{OUT} output voltage being within regulation.	--	3000	ms
T _{12VOUT_HOLDUP}	Time 12V _{OUT} output voltage stays within regulation after loss of AC with specified load in section 2.	10	--	ms
T _{PWOK_HOLDUP}	Delay from loss of AC to de-assertion of PWOK with specified load in section 2	9	--	ms
T _{PSON#_ON_DELAY}	Delay from PSON# active to output voltages within regulation limits.	5	400	ms
T _{PSON#_PWOK}	Delay from PSON# deactivate to PWOK being de-asserted.	--	5	ms
T _{PWOK_ON}	Delay from output voltages within regulation limits to PWOK asserted at turn on	100	500	ms
T _{PWOK_OFF}	Delay from PWOK de-asserted to output voltages dropping out of regulation limits.	1	--	ms
T _{PWOK_LOW}	Duration of PWOK being in the de-asserted state during an off/on cycle using AC or the PSON# signal.	100	--	ms
T _{VSB_12Vout}	Delay from VSB being in regulation to 12V _{OUT} output voltage being in regulation at AC turn on.	50	1000	ms
T _{VSB_HOLDUP}	Time the V _{SB} standby voltage stays within regulation after loss of AC.	70	--	ms

6 POWER SUPPLY COMMUNICATION

6.1 OVERVIEW

The Power Management Bus features included in this specification are requirements for AC/DC golden box PSU for use in server systems. This specification is based on the Power Management Bus specifications parts I and II, revision 1.2.

6.2 RELATED DOCUMENTS

Power Management Bus Power System Management Protocol Specification Part I – General Requirements, Transport and Electrical Interface; Revision 1.2.

Power Management Bus Power System Management Protocol Specification Part II – Command Language; Revision 1.2. SMBus 2.0.

6.3 HARDWARE CONNECTING

The device in the power supply shall be compatible with both SMBus 2.0 'high power' specification for I2C Vdd based power and drive (for Vdd = 3.3V). This bus shall operate at 3.3V.

The circuits inside the power supply shall derive their power from the standby output. For redundant power supplies the device(s) shall be powered from the system side of the or'ing device. The Power Management Bus device shall be on whenever AC power is applied to the power supply or a parallel redundant power supply in the system.

Only weak pull-up resistors shall be on SCL or SDA inside the power supply. The main pull-up resistors are provided by the system and may be connected to 3.3Vsb. For the system design, the main pull-ups shall be located external to the power supply and derive their power from the standby rail.

6.4 DATA SPEED

The Power Management Bus device in the power supply shall operate at the full 100 kbps SMBus speed and avoid using clock stretching that can slow down the bus. For example, the power supply can clock stretch while parsing a command or a power supply servicing multiple internal interrupts or NACK may require some use of clock stretching.

The Power Management Bus device shall support SMBus cumulative clock low extend time (Tlow:sect) if < 25msec.

This requires the device to extend the clock time no more than 25msec between START and STOP for any given message.

6.5 BUS ERROR

The Power Management Bus device shall support SMBus clock-low timeout (Ttimeout). This capability requires the device to abort any transaction and drop off the bus if it detects the clock being held low for >25ms, and be able to respond to new transactions 10ms later.

The device must recognize SMBus START and STOP conditions on ANY clock interval. (These are requirements of the SMBus specifications, but are often missed in first-time hardware designs.) The device must not hang due to 'runt clocks', 'runt data', or other out-of-spec bus timing. This is defined as signals, logic-level glitches, setup, or hold times that are shorter than the minimums specified by the SMBus specification. The device is not required to operate normally, but must return to normal operation once 'in spec' clock and data timing is again received. Note if the device 'misses' a clock from the master due to noise or other bus errors, the device must continue to accept 'in spec' clocks and re-synch with the master on the next START or STOP condition.

6.6 FRU DATA FORMAT

For identification of the power supply an internal 256x8 bit EEPROM with Power Management Bus interface is used. The information in the EEPROM follows the IPMI (Platform Management FRU Information Storage Definition) guidelines Document Revision 1.1 from November 15, 1999.



6.7 COMMUNICATION ADDRESS

Four pins will be allocated for the FRU and Power Management Bus information on the Power Supply connector. One pin is the serial clock (SCL). The second pin is used for serial data (SDA). Two pins are for address lines A0-A1 to indicate to the power supply's EEPROM and MCU, which position the power supply is located in the system. The SCL and SDA signals are pulled up by system, the address lines are also pulled up by system.

A1 LOGICAL VOLTAGE	A0 LOGICAL VOLTAGE	PSU ADDRESS	FRU ADDRESS
0	0	0xB0	0xA0
0	1	0xB2	0xA2
1	0	0xB4	0xA4
1	1	0xB6	0xA6

PRELIMINARY

7 POWER MANAGEMENT BUS CONTENT

7.1 POWER MANAGEMENT BUS COMMAND TABLE

Via the Power Management Bus the computer system can communicate with the power supply to access currents, voltages, fan control and speed and temperatures. The communication follows the Power System Management Protocol Specification. (Power Management Bus 1.2). As soon as AC Power is connected to the PSU the Power Management Bus functionality must be available.

Following Table shows mandatory Power Management Bus commands to be supported by the PSU.

COMMAND CODE	COMMAND NAME	SMBUS TRANSACTION TYPE:		NUMBER OF DATA BYTES	COMMENT
		WRITING DATA	READING DATA		
00h	PAGE	Write Byte	Read Byte	1	
01h	OPERATION	Write Byte	Read Byte	1	0x80 ON; 0x00 OFF Default: 0x80
02h	ON_OFF_CONFIG	Write Byte	Read Byte	1	
03h	CLEAR_FAULTS	Send Byte	N/A	0	
05h	PAGE_PLUS_WRITE	Block Write	N/A	Variable	
06h	PAGE_PLUS_READ	N/A	Block Write – Block Read	Variable	
19h	CAPABILITY	N/A	Read Byte	1	0xB0
1Ah	QUERY	N/A	Block Write – Block Read	1	
1Bh	SMBAlert#_MASK	Write Word	Block Write – Block Read	2	
20h	VOUT_MODE		Read Byte	1	0x17 (n=-9)
21h	VOUT_COMMAND	Write Word	Read Word	2	
30h	COEFFICIENTS	N/A	Block Write – Block Read	5	Use for Ein/Eout
31h	POUT_MAX	N/A	Read Word	2	
3Ah	FAN_CONFIG_1_2	Write Byte	Read Byte	1	Default is duty
3Bh	FAN_COMMAND_1	Write Word	Read Word	2	
4Ah	IOUT_OC_WARN_LIMIT		Read Word	2	
51h	OT_WARN_LIMIT		Read Word	2	
5Dh	IIN_OC_WARN_LIMIT		Read Word	2	
6Ah	POUT_OP_WARN_LI MIT		Read Word	2	
6Bh	PIN_OP_WARN_LIMIT		Read Word	2	
78h	STATUS_BYTE	Write Byte	Read Byte	1	
Bit 6	OFF				
Bit 5	VOUT_OV_FAULT				
Bit 4	IOUT_OC				
Bit 3	VIN_UV				
Bit 2	TEMPERATURE				
Bit 1	CML				
Bit 0	NON OF THE ABOVE				
79h	STATUS_WORD	Write Word	Read Word	2	
Bit 7(H)	VOUT				
Bit 6	IOUT/POUT				
Bit 5	INPUT				
Bit 3	POWER_GOOD#				
Bit 2	FANS				



Bit 6(L)	OFF				
Bit 5	VOUT_OV_FAULT				
Bit 4	IOUT_OC_FAULT				
Bit 3	VIN_UV_FAULT				
Bit 2	TEMPERATURE				
Bit 1	CML				
Bit 0	NON OF THE ABOVE				
7Ah	STATUS_VOUT	Write Byte	Read Byte	1	
Bit 7	VOUT_OV_FAULT				
Bit 4	VOUT_UV_FAULT				
7Bh	STATUS_IOUT	Write Byte	Read Byte	1	
Bit 7	Iout OC fault				
Bit 5	Iout OC warning				
Bit 1	Pout OP fault				
Bit 0	Pout OP warning				
7Ch	STATUS_INPUT	Write Byte	Read Byte	1	
Bit 5	Vin UV warning				
Bit 4	Vin UV fault				
Bit 3	Unit off for insufficient input				
Bit 1	Iin over current warning				
Bit 0	Pin over power warning				
7Dh	STATUS_TEMPERATURE	Write Byte	Read Byte	1	
Bit 7	OT fault				
Bit 6	OT warning				
7Eh	STATUS_CML	Write Byte	Read Byte	1	
Bit 7	Invalid COMMAND				
Bit 6	Invalid DATA				
Bit 5	PEC Failed				
81h	STATUS_FANS_1_2	Write Byte	Read Byte	1	
Bit 7	Fan 1 fault				
Bit 5	Fan 1 warning				
Bit 3	Fan1 speed overridden				
86h	READ_EIN	N/A	Block Read	6	DIRECT Data Format
87h	READ_EOUT	N/A	Block Read	6	DIRECT Data Format
88h	READ_VIN	N/A	Read Word	2	Linear
89h	READ_IIN	N/A	Read Word	2	Linear
8Bh	READ_VOUT	N/A	Read Word	2	Linear16
8Ch	READ_IOUT	N/A	Read Word	2	Linear
8Dh	READ_TEMPERATURE_1	N/A	Read Word	2	Ambient
8Eh	READ_TEMPERATURE_2	N/A	Read Word	2	SR Hotspot
8Fh	READ_TEMPERATURE_3	N/A	Read Word	2	PFC Hotspot
90h	READ_FAN_SPEED_1	N/A	Read Word	2	In RPM
96h	READ_POUT	N/A	Read Word	2	Linear
97h	READ_PIN	N/A	Read Word	2	Linear
98h	PMBUS_REVISION	N/A	Read Byte	1	1.2
99h	MFR_ID	Block Write	Block Read	Variable (3)	"bel"
9Ah	MFR_MODEL	Block Write	Block Read	Variable (16)	"TEC3200-12-074NA"
9Bh	MFR_REVISION	Block Write	Block Read	Variable (3)	"RXX"
9Ch	MFR_LOCATION	Block Write	Block Read	Variable (5)	"CHINA"
9Dh	MFR_DATE	Block Write	Block Read	Variable (8)	"YYYYMMDD"
9Eh	MFR_SERIAL	Block Write	Block Read	Variable (19)	Serial Number

9Fh	APP_PROFILE_SUPPORT	N/A	Block Read	Variable (2)	PMBus 1.2
A0h	MFR_VIN_MIN	N/A	Read Word	2	90V
A1h	MFR_VIN_MAX	N/A	Read Word	2	264V
A2h	MFR_IIN_MAX	N/A	Read Word	2	
A3h	MFR_PIN_MAX	N/A	Read Word	2	
A4h	MFR_VOUT_MIN	N/A	Read Word	2	11.6V
A5h	MFR_VOUT_MAX	N/A	Read Word	2	12.8V
A6h	MFR_IOUT_MAX	N/A	Read Word	2	
A7h	MFR_POOUT_MAX	N/A	Read Word	2	
A8h	MFR_TAMBIENT_MAX	N/A	Read Word	2	
A9h	MFR_TAMBIENT_MIN	N/A	Read Word	2	
AAh	MFR_EFFICIENCY_LL	N/A	Block Read	14	At 20%/50%/100%
ABh	MFR_EFFICIENCY_HL	N/A	Block Read	14	At 20%/50%/100%
B0h	PMBUS_MFR_CALIBRATION_0xB0	Block Write	Block Read	Variable	
C0h	MFR_MAX_TEMP_1	N/A	Read Word	2	
C1h	MFR_MAX_TEMP_2	N/A	Read Word	2	
C2h	MFR_MAX_TEMP_3	N/A	Read Word	2	
C3h	MFR_FAN_MAX_RPM	N/A	Read Word	2	Linear
C4h	MFR_FAN_MIN_RPM	N/A	Read Word	2	Linear
D0h	MFR_COLD_REDUNDANCY_CONFIG	Write Byte	Read Byte	1	
D4h	MFR_HW_COMPATIBILITY	N/A	Read Word	2	
D5h	MFR_FWUPLOAD_CAPABILITY	N/A	Read Byte	1	
D6h	MFR_FWUPLOAD_MODE	Write Byte	Read Byte	1	
D7h	MFR_FWUPLOAD	Block Write	N/A		
D8h	MFR_FWUPLOAD_STATUS	N/A	Read Word	21	
D9h	MFR_FW_REVISION	N/A	Block Read	3	
DBh	MFR_FRU_PROTECTION	Write Byte	Read Byte	1	
DCh	MFR_BLACK_BOX	N/A	Block Read	238	
DDh	MFR_REAL_TIME	Block Write	Block Read	4	

Note: Write protocol must include PEC (Packet error checking).



7.2 STATUS COMMANDS

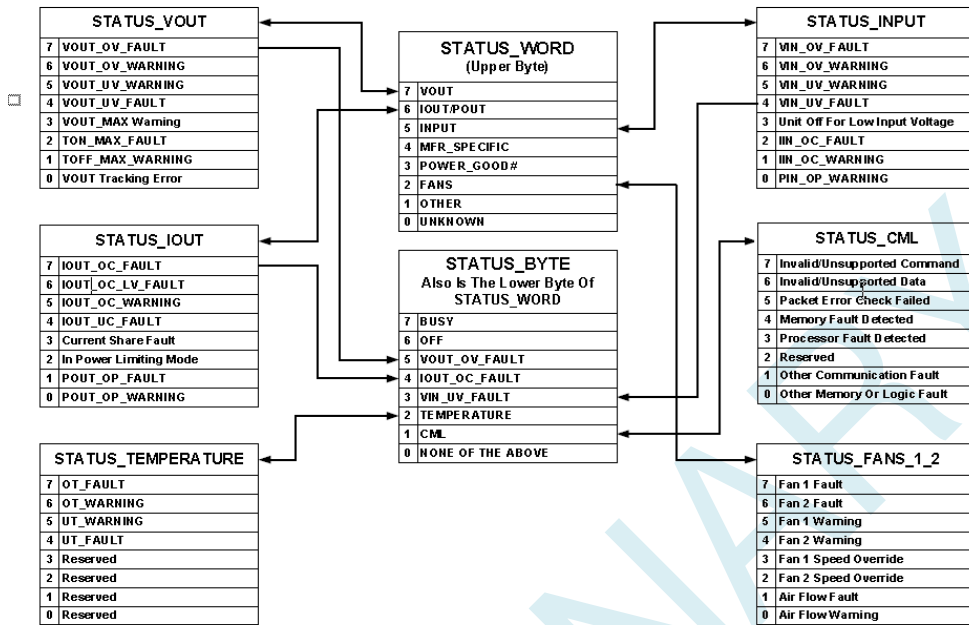

Figure 2. Summary of the Status Registers

The following Power Management Bus STATUS commands shall be supported. All STATUS commands stated in Table Supporting PAGE instances shall support the PAGE_PLUS_WRITE and PAGE_PLUS_READ commands since they are used by both the BMC and ME. The BMC and ME refer to the two instances of the commands accessed via the PAGE_PLUS_WRITE and PAGE_PLUS_READ commands. The status bits shall assert whenever the event driving the status bit is present. Once a bit is asserted it shall stay asserted until cleared

The STATUS commands that are supported with the PAGE_PLUS_READ and PAGE_PLUS_WRITE commands shall still support direct access of the base STATUS_XXX commands using the read word, write word, read byte, and write byte protocols.

STATUS_FAN_1_2 command is only accessed by the system BMC. It uses the standard read byte protocol to read status and write byte protocol to clear bits.

The STATUS events are also used to control the SMBAlert# signal. The new SMBALERT_MASK command is used to define which status event control the SMBAlert# signal. Default values for these mask bits are shown in the table below.

Power Management Bus command	Bit location	PSU state when bit is asserted ('1')	Instances No PAGE'ing ² PAGE 00h = BMC PAGE 01h = ME	SMBALERT_MASK defaults for each of the three instances (No PAGE, PAGE 00h, PAGE 01h) 0 = causes assertion of SMBAlert# 1 = does not cause assertion of SMBAlert#
STATUS_WORD			No PAGE, 00h, 01h	
OFF	6 (lower)	OFF		NA
IOUT_OC_FAULT	4 (lower)	Refer to STATUS_IOUT		NA
VIN_UV_FAULT	3 (lower)	Refer to STATUS_INPUT		NA
TEMPERATURE	2 (lower)	Refer to STATUS_TEMPERATURE		NA
CML	1 (lower)	ON		NA
VOUT	7 (upper)	Refer to STATUS_VOUT		NA
IOUT/POUT	6 (upper)	Refer to STATUS_IOUT		NA
INPUT	5 (upper)	Refer to STATUS_INPUT		NA
FANS	2 (upper)	Refer to STATUS_FANS		NA
STATUS_VOUT			No PAGE'ing	
VOUT_OV_FAULT	7	OFF		1, 1, 1



VOUT_UV_FAULT	4	OFF		1, 1, 1
STATUS_IOUT			No PAGE'ing, 00h,01h	
IOUT_OC_FAULT	7	OFF		1, 1, 1
IOUT_OC_WARNING	5	ON		1, 1, 0
POUT_OP_FAULT	1	OFF		1, 1, 1
POUT_OP_WARNING	0	ON		1, 1, 1
STATUS_INPUT			No PAGE'ing, 00h,01h	
VIN_UV_WARNING	5	ON		1, 1, 1
VIN_UV_FAULT ¹	4	OFF		1, 1, 0
Unit off for low input voltage	3	OFF		1, 1, 1
IIN_OC_WARNING	1	ON		1, 1, 1
PIN_OP_WARNING	0	ON		1, 1, 1
STATUS_TEMPERATURE			No PAGE'ing, 00h,01h	
OT_FAULT	7	OFF		1, 1, 1
OT_WARNING	6	ON		1, 1, 0
STATUS_FANS_1_2			No PAGE'ing	
Fan 1 fault ³	7	OFF		1, 1, 1
Fan 1 warning ³	5	ON		1, 1, 1

Table 1. Power Management Bus* STATUS Commands Summary

- 1 The Vin Fault bit in STATUS_INPUT shall get asserted if the input power has dropped below the PSU's operating range for any duration of time; even if the PSU continues to operate normally through a momentary input dropout event.
- 2 'No PAGE' is the standard STATUS_ commands accessed directly without using the PAGE_PLUS commands.
- 3 All fans in the PSU shall be OR'ed into a single fan status bit for fault and warning conditions.

7.3 POWER MANAGEMENT BUS TEMPERATURE READ COMMANDS

The following temperature read commands as documented by the Power Management Bus specification Part II version 1.2 should be supported.

READ_TEMPERATURE_1(8Dh), should provide the PSU inlet temperature.

READ_TEMPERATURE_2(8Eh), should provide the temperature of the SR heat sink in the PSU.

READ_TEMPERATURE_3(8Fh), should provide the temperature of the PFC heat sink in the PSU.

7.4 PAGE (00h)

Setting a PAGE value of FFh is used to clear all status bits in all PAGEs with the CLEAR_FAULT command.

7.5 OPERATION (01h)

The OPERATION command is used to configure the operational state of the converter, in conjunction with input from the CONTROL pin. The OPERATION command is used to turn the Power Management Bus device output on and off.

Bit [7] controls whether the Power Management Bus device output is on or off.

If Bit [7] is cleared (equals 0) then the output is off. If Bit [7] is set (equals 1), then the output is on.

7.6 ON_OFF_CONFIG (02h)

The ON_OFF_CONFIG command configures the combination of CONTROL pin input and serial bus commands needed to turn the unit on and off. This includes how the unit responds when power is applied. The default response for any Power Management Bus device is specified by the device manufacturer. The details of the ON_OFF_CONFIG data byte.

Example conditions:

If bit [4] is cleared, then the unit powers up and operates any time bias power is available regardless of the setting of bits [3:0].

If bit [4] is set, bit [3] is set, and bit [2] is cleared, then the unit is turned on and off only by commands received over the serial bus.



If bit [4] is set, bit [3] is cleared, and bit [2] is set, then the unit is turned on and off only by the CONTROL pin.

If bit [4] is set, bit [3] is set, and bit [2] is set, then the unit is turned on and off only when both the commands received over the serial bus AND the CONTROL pin are commanding the device to be on. If either a command from the serial bus OR the CONTROL pin commands the unit to be off, the unit turns off.

BIT NUMBER	PURPOSE	BIT VALUE	MEANING
[7:5]		000	Reserved For Future Use
4	Sets the default to either operate any time power is present or for the on/off to be controlled by CONTROL pin and serial bus commands	0	Unit powers up any time power is present regardless of state of the CONTROL pin
		1	Unit does not power up until commanded by the CONTROL pin and OPERATION command (as programmed in bits [3:0]).
3	Controls how the unit responds to commands received via the serial bus	0	Unit ignores the on/off portion of the OPERATION command from serial bus
		1	To start, the unit requires that that the on/off portion of the OPERATION command is instructing the unit to run. Depending on bit [2], the unit may also require the CONTROL pin to be asserted for the unit to start and energize the output.
2	Controls how the unit responds to the CONTROL pin	0	Unit ignores the CONTROL pin (on/off controlled only the OPERATION command)
		1	Unit requires the CONTROL pin to be asserted to start the unit. Depending on bit [3], the OPERATION command may also be required to instruct the device to start before the output is energized.
1	Polarity of the CONTROL pin	0	Active low (Pull pin low to start the unit)
		1	Active high (Pull high to start the unit)
0	CONTROL pin action when commanding the unit to turn off	0	Use the programmed turn off delay and fall time
		1	Turn off the output and stop transferring energy to the output as fast as possible. The device's product literature shall specify whether or not the device sinks current to decrease the output voltage fall time.

7.7 CLEAR_FAULTS COMMAND (03h)

The CLEAR_FAULTS command is used to clear any fault bits that have been set. This command clears all bits in all status registers simultaneously. At the same time, the device negates (clears, releases) its SMBAlert# signal output if the device is asserting the SMBAlert# signal.

7.8 PAGE_PLUS_WRITE / PAGE_PLUS_READ COMMANDS (05h/06h)

The new PAGE_PLUS_WRITE and PAGE_PLUS_READ commands are used with the STATUS_WORD, STATUS_INPUT, STATUS_TEMPERATURE, STATUS_IOUT, STATUS_VOUT, and STATUS_CML to create two instances of the same command. Each instance is set by the same events but cleared by their own master in the system. The instances at PAGE 00h are controlled by the system BMC and the instances at PAGE 01h are controlled by the system ME. Below are the protocols used to read and clear the STATUS_ commands using the PAGE_PLUS_WRITE and PAGE_PLUS_READ commands.

Reading STATUS_WORD

Block Write – Block Read Process Call with PEC

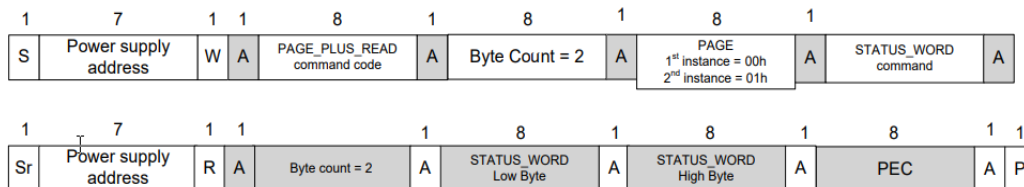

Reading STATUS_TEMPERATURE, STATUS_IOUT, STATUS_INPUT, STATUS_CML

Block Write – Block Read Process Call with PEC

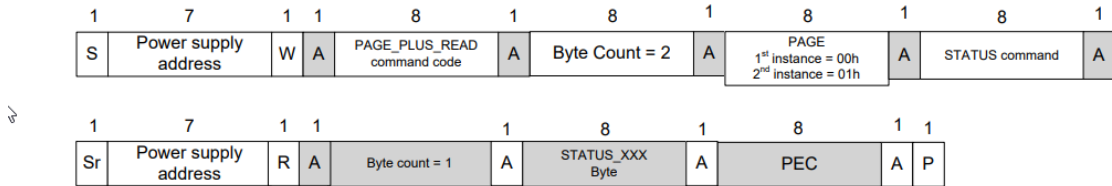

Clearing STATUS commands (write '1' to clear a bit) STATUS_TEMPERATURE, STATUS_IOUT, STATUS_INPUT, STATUS_CML

Block Write with PEC

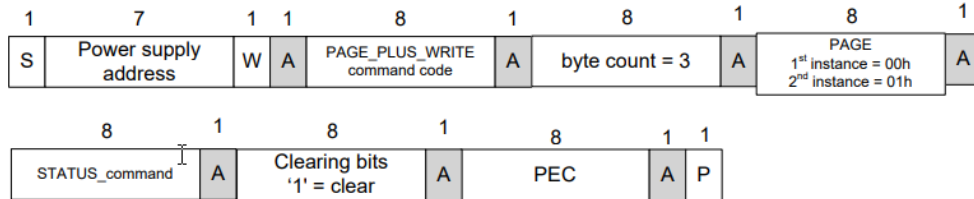

STATUS_WORD cannot be cleared directly It is cleared based on lower level status commands

7.9 CAPABILITY (19h)

This command provides a way for a host system to determine some key capabilities of a Power Management Bus device. There is one data byte formatted as shown in Table. This command is read only.

BITS	DESCRIPTION	VALUE	MEANING
7	Packet Error Checking	0	Packet Error Checking not supported
		1	Packet Error Checking is supported
6:5	Maximum Bus Speed	00	Maximum supported bus speed is 100 kHz
		01	Maximum supported bus speed is 400 kHz
		10	Reserved
		11	Reserved
4	SMBAlert#	0	The device does not have a SMBAlert# pin and does not support the SMBus Alert Response protocol
		1	The device does have a SMBAlert# pin and does support the SMBus Alert Response protocol
3:0	Reserved	X	Reserved

Table 2. CAPABILITY COMMAND Data Byte Format

7.10 QUERY (1Ah)

The QUERY command is used to ask a Power Management Bus device if it supports a given command, and if so, what data formats it supports for that command. This command uses the Block Write-Block Read Process Call described in the SMBus specification.

BITS	VALUE	MEANING
7	1	Command is supported
	0	Command is not supported
6	1	Command is supported for write



	0	Command is not supported for write
5	1	Command is supported for read
	0	Command is not supported for read
	000	Linear Data Format used
	001	16 bit signed number
	010	Reserved
	011	Direct Mode Format used
4:2	100	8 bit unsigned number
	101	VID Mode Format used
	110	Manufacturer specific format used
	111	Command does not return numeric data. This is also used for commands that return blocks of data.
1:0	XX	Reserved for future use

If bit [7] is zero, then the rest of the bits are “don’t care”.

Table 3. QUERY Command Returned Data Byte Format

7.11 SMBALERT_MASK (1Bh)

This allows the system to mask events from asserting the SMBAlert# signal and to read back this information from the PSU. SMBALERT_MASK command can be used with any of the supported STATUS events. The events are masked from asserting SMBAlert# by writing a ‘1’ to the associated STATUS bits. The SMBALERT_MASK command is used in conjunction with the PAGE_PLUS command and STATUS_ commands. It is not supported for masking the Non-PAGE'd STATUS_ commands. Below are the protocols.

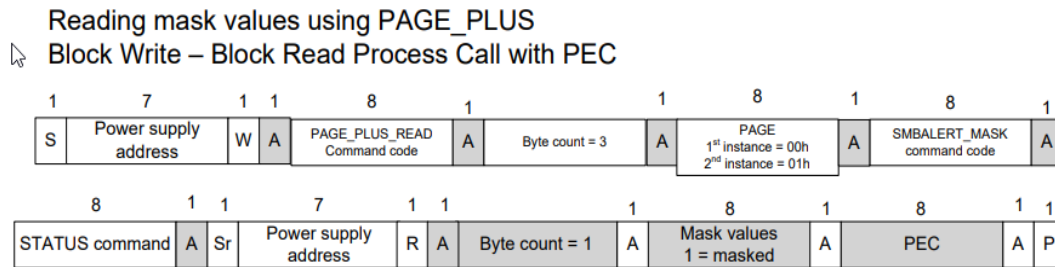
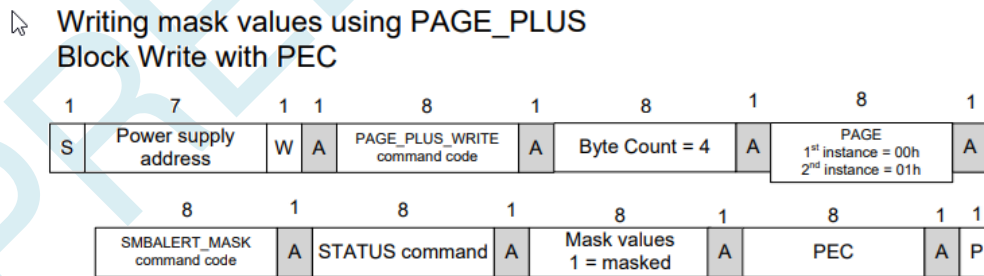

Figure 3. PAGE_PLUS_READ command.



STATUS_WORD is not used with SMBALERT_MASK. Only the 'root' event bits are used to control the SMBAlert signal

Figure 4. PAGE_PLUS_WRITE command.

7.12 COEFFICIENT (30h)

The power supply shall support the Power Management Bus COEFFICIENT command. The system shall use this to read the values of m, b, and R used to determine READ_EIN and READ_EOUT accumulated power values.

COMMAND	COEFFICIENTS SUPPORT	M	B	R
READ_EIN	Yes	01h	00h	00h
READ_EOUT	Yes	01h	00h	00h

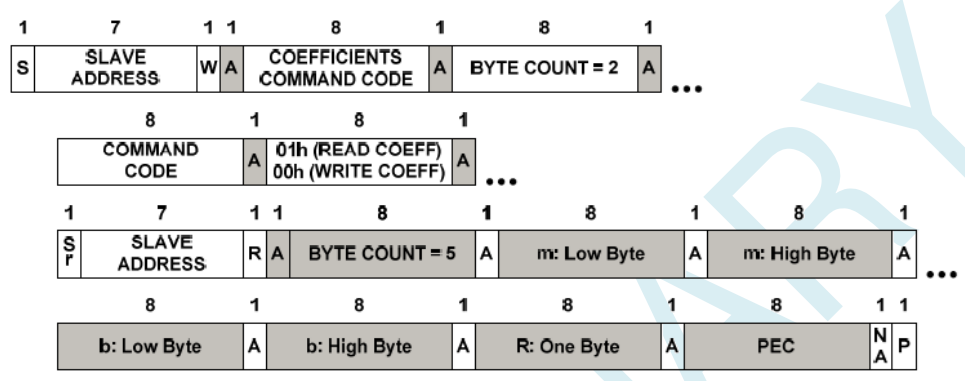

Figure 5. Retrieving Coefficients Using PEC

7.13 FAN_CONFIG_1_2 (3Ah)

The FAN_CONFIG_1_2 command is used to define the presence of a fan and the method it is controlled (by duty cycle or RPM).

The first of the configuration tells the Power Management Bus device whether or not a fan associated with position 1 (or 2) is installed. Any combination of fan installation is permitted.

The second part of the configuration tells the device whether the fan speed commands are in RPM or PWM duty cycle (in percent). These settings do not have to be the same for Fan 1 and Fan 2.

The third part of the configuration data tells the Power Management Bus device the number of tachometer pulses per revolution each fan provides. This information is commanding and reporting fan speed in RPM. Two bits are provided for each fan. These settings do not have to be the same for Fan 1 and Fan 2. The binary values of these bits map to pulses per revolution as follows:

- 00b = 1 pulse per revolution,
- 01b = 2 pulses per revolution,
- 10b = 3 pulses per revolution,
- 11b = 4 pulses per revolution.

This command has one data byte formatted as follows:

BITS	VALUE	MEANING
7	1	Fan in position 1
6	0	Fan 1 commanded in Duty Cycle
	1	Fan 1 commanded in RPM
5:4	00b-11b	Fan 1 Tachometer Pulses Per Revolution
3	0	No fan in position 2
2	Not used	
1:0	Not used	

Table 4. FAN_CONFIG_1_2 Command



7.14 FAN_COMMAND_1 (3Bh)

The system may increase the power supplies fan speed through using the FAN_COMMAND_1 command. This command can only increase the power supplies fan speed; it cannot decrease the PSU fan speed below what the PSU minimum speed of the thermal requirement.

The default control mode of fan is duty (0~100).

7.15 READ_FAN_SPEED_1 (90h)

The system will read the fan speed by using the READ_FAN_SPEED_1 command. This data shall return the fan speed in the Power Management Bus linear format.

7.16 POWER MANAGEMENT BUS_REVISION (98h)

This is a correction to the table in the Power Management Bus part II specification regarding the POWER MANAGEMENT BUS_REVISION command.

BITS [7:4]	PART I REVISION	BITS [3:0]	PART II REVISION
0000	1.0	0000	1.0
0001	1.1	0001	1.1
0010	1.2	0010	1.2
0011	1.3	0011	1.3

Table 5. POWER MANAGEMENT BUS_REVISION Command

7.17 MFR-EFFICIENCY_LL (AAh)

The MFR_EFFICIENCY_LL command sets or retrieves information about the efficiency of the device while operating at a low line condition. Not including the PEC byte, if used, and the byte count byte, there are fourteen data bytes as described below. The efficiency is specified at one input voltage and three data points consisting of output power and the efficiency at that output power. The three power ratings are typically referred as low, medium and high output power and are transmitted in that order. For example, the low, medium and high output power might correspond to 20%, 50% and 100% of the rated output power. The exact values of the output power is specified is left to the Power Management Bus device manufacturer. Each value (voltage, power or efficiency) is transmitted as two bytes in linear format.

BYTE NUMBER	BYTE ORDER	DESCRIPTION
0	Low Byte	The input voltage, in volts, at which the high line efficiency data is applicable. Note that byte 0 is the first data byte transmitted as part of the block transfer.
1	High Byte	
2	Low Byte	Power, in watts, at which the low power efficiency is specified
3	High Byte	
4	Low Byte	The efficiency, in percent, at the specified low power.
5	High Byte	
6	Low Byte	Power in watts, at which the medium power efficiency is specified
7	High Byte	
8	Low Byte	The efficiency, in percent, at the specified medium power.
9	High Byte	
10	Low Byte	Power, in watts, at which the high power efficiency is specified
11	High Byte	
12	Low Byte	The efficiency, in percent, at the specified high power. Note that byte 13 is the last data byte transmitted as part of the block transfer.
13	High Byte	

Table 6. MFR_EFFICIENCY_LL

7.18 MFR-EFFICIENCY_HL (ABh)

The MFR_EFFICIENCY_HL command sets or retrieves information about the efficiency of the device while operating at a high line condition. Not including the PEC byte, if used, and the byte count byte, there are fourteen data bytes as described below. The efficiency is specified at one input voltage and three data points consisting of output power and the efficiency at that output power. The three power ratings are typically referred as low, medium and high output power and are transmitted in that order. For example, the low, medium and high output power might correspond to 20%, 50% and 100% of the rated output power. The exact values of the output power is specified is left to the Power Management Bus device manufacturer. Each value (voltage, power or efficiency) is transmitted as two bytes in linear format.

BYTE NUMBER	BYTE ORDER	DESCRIPTION
0	Low Byte	The input voltage, in volts, at which the high line efficiency data is applicable. Note that byte 0 is the first data byte transmitted as part of the block transfer.
1	High Byte	
2	Low Byte	Power, in watts, at which the low power efficiency is specified
3	High Byte	
4	Low Byte	The efficiency, in percent, at the specified low power.
5	High Byte	
6	Low Byte	Power in watts, at which the medium power efficiency is specified
7	High Byte	
8	Low Byte	The efficiency, in percent, at the specified medium power.
9	High Byte	
10	Low Byte	Power, in watts, at which the high power efficiency is specified
11	High Byte	
12	Low Byte	The efficiency, in percent, at the specified high power. Note that byte 13 is the last data byte transmitted as part of the block transfer.
13	High Byte	

Table 7. MFR_EFFICIENCY_HL

7.19 READ_EIN (86H)

The new READ_EIN command is used to allow the system to apply its own input power filtering. This will allow the system to get faster input power data while preventing aliasing. The command returns an accumulated power value and an associated sample count of number of accumulated power values. This allows the system to calculate its own average power value each time the system polls the PSU.

	MIN	MAX	Description
Format	Power Management Bus Direct format m = 01h, R = 00h, b = 00h		Power Management Bus data format; refer to Power Management Bus specification for details.
Psample averaging period	4 AC cycles		Period instantaneous input power is averaged over to calculate Psample.
READ_EIN update period	80/66.7ms (50/60Hz)		Period at which the power accumulator and sample counter are updated
Range of System polling period	1 sec	100 ms	The PSU shall be polled over this range of rates while testing accuracy.

IMPORTANT:

The PSU READ_EIN update period MUST always be less than the system polling period. To make sure the PSU is compatible with all possible system polling periods; the PSU must update the READ_EIN power accumulator and sample counter at a period less than 100msec (required period is 4 AC cycles 80/67msec).

Table 8. READ_EIN Requirements Summary

7.20 READ_EOUT (87H)

The new READ_EOUT command is used to allow the system to apply its own output power filtering. This will allow the system to get faster output power data while preventing aliasing. The command returns an accumulated power value and an associated sample count of number of accumulated power values. This allows the system to calculate its own average power value each time the system polls the PSU.



	MIN	MAX	Description
Format	Power Management Bus Direct format m = 01h, R = 00h, b = 00h		Power Management Bus data format; refer to Power Management Bus specification for details.
Psample averaging period	Nominal 50msec		Period instantaneous input power is averaged over to calculate P _{sample} .
Sampling period	Nominal 50msec		Period at which the power accumulator and sample counter are updated
System polling rate	1 sample /s	10 samples /s	The PSU shall be polled over this range of rates while testing accuracy.

Table 9. READ_EOUT Requirements Summary

7.21 READ_EIN & READ_EOUT FORMATS

The READ_EIN and READ_EOUT commands shall use the Power Management Bus direct format to report an accumulated power value and the sample count. The Power Management Bus coefficients m, R, and b shall be fixed values and the PSU shall report these values using the Power Management Bus COEFFICIENTS command. The coefficient m shall be set to 01h, coefficient R shall be set to 00h, and coefficient b shall be set to 00h.

READ_EIN and READ_EOUT shall use the SMBus Block Read with PEC protocol in the below format.

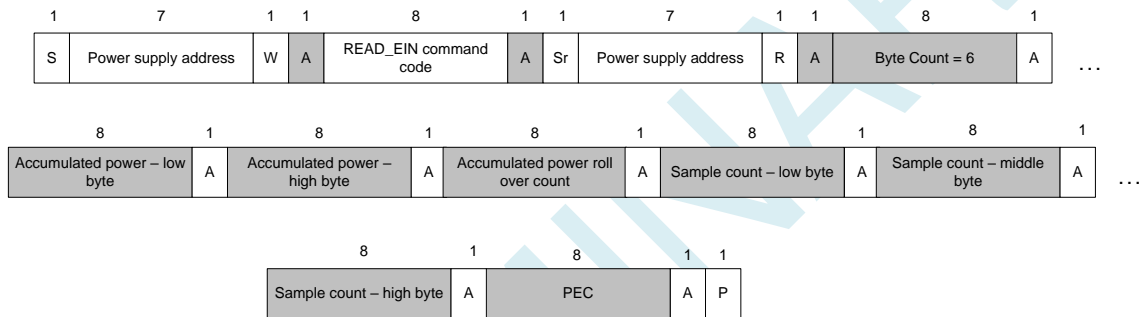

Figure 6. READ_EIN Command

The accumulated power data shall be the sum of input power values averaged over 4 AC cycles (or over 50ms for READ_EOUT). The value shall automatically roll-over when the 15 bit maximum value is reached (> 7FFFh). The sample count should increment 1 for each accumulated power value. The system shall calculate average power by dividing the accumulated power value by the sample count. The system must sample READ_EIN and READ_EOUT faster than the roll-over period to get an accurate power calculation. Below is a block diagram depicting the accumulator function in the PSU.

Important note: When the PSU responds to the system requesting READ_EIN or READ_EOUT data; the data in the sample count must always alignment with the number of samples accumulated in the power accumulator. To achieve this power accumulator, power rollover counter, and sample counter shall be loaded into a READ_EIN and READ_EOUT register at the same time.

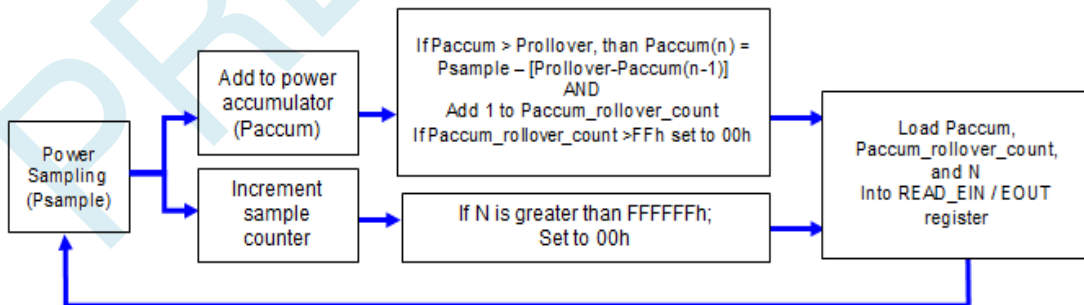

Figure 7. READ_EIN PSU Functional Diagram

VALUE	DESCRIPTION
Psample:	The sampled power value in linear or direct format
Paccum:	2 bytes in Power Management Bus linear or direct format. The accumulated power values made up of Psample(0) + Psample(1) + Psample(n)
N:	3 byte unsigned integer value. The number of accumulated power values summed in Paccum
Prollover:	The max value of Paccum before a rollover will occur
Paccum_rollover_count:	1 byte unsigned integer counting the number of times Paccum rolls over. Once this reaches FFh; it will automatically get reset to 00h

7.22 POWER SUPPLY ACCURACY

The following Power Management Bus commands shall be supported for the purpose of monitoring current, voltage, and power. All sensors shall continue providing real time data as long as the Power Management Bus device is powered. This means in standby mode the main output(s) of the PSU shall be zero amps and zero volts. Sensors shall meet requirements at nominal input voltage; maximum deviation for the ambient temperature is +/- 4°C.

	10% - <20% Load	>= 20% - 50% Load	> 50% - 100% Load
P_{IN} / E_{IN}	+/- 5%	+/- 2%	+/- 2%
V_{IN}	+/-5%	+/- 2%	+/- 2%
I_{IN}	+/-5%	+/-2%	+/-2%
FAN		+/- 500 rpm	
12V_{OUT}		+/- 2%	
I_{OUT}	+/-5%	+/-2%	+/-2%
P_{OUT}	+/- 5%	+/-2%	+/-2%
AMB Temperature		+/- 2°C	

Table 10. Required Accuracy

Note.1:

The spec is based on input voltage 115Vac, 230Vac and 240Vdc measurement, the Max. output may be different between low and high line, the load definition where is taken Max. value.

Note.2: In 240Vdc application, no matter the input polarity is positive or negative, the PSU could operate normally, but Accuracy shall be measured when positive polarity on Neutral. If customer may apply positive polarity on either one, please inform bel early.

Note.3: For light load reporting requirement, in the normal redundant application, PSU shall report below value to system once the below condition is set, which is not included the PSU that in cold redundant mode and set as slave.

For system power calculation requirement, the reporting performance shall make sure the Pin > Pout situation,

Note.4: The accuracy of AMB temperature is defined as the temperature around the temperature sensor inside of PSU, thereby this accuracy performance shall measure the closest point on the inlet chassis to internal temperature sensor.

7.23 LINEAR DATA FORMAT

The Linear Data Format is typically used for commanding and reporting the parameters such as (but not only) the following:

- Output Current,
- Input Voltage,
- Input Current,
- Operating Temperatures,
- Time (durations), and Energy Storage Capacitor Voltage.

The Linear Data Format is a two byte value with:

- An 11 bit, two's complement mantissa and,
- A 5 bit, two's complement exponent (scaling factor),
- The format of the two data bytes is illustrated in Figure 5.1 as show below.



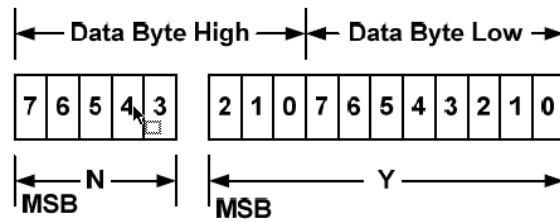

Figure 8. Linear Data Format Data Bytes

The relation between Y, N and the “real world” value is:

$$X = Y \cdot 2^N$$

Where, as described above:

- X is the “real world” value;
- Y is an 11 bit, two’s complement integer; and
- N is a 5 bit, two’s complement integer.

Devices that use the linear format must accept and be able to process any value of N.

7.24 VOUT_MODE (20H)

The data byte for the VOUT_MODE command is one byte that consists of a three bit Mode and a five bit exponent. The three bit Mode shall be set to indicate the LINEAR mode for output voltage related commands. The five bit Exponent shall be set to indicate the value of the five bit two’s complement exponent for the mantissa delivered as the data bytes for an output voltage related command.

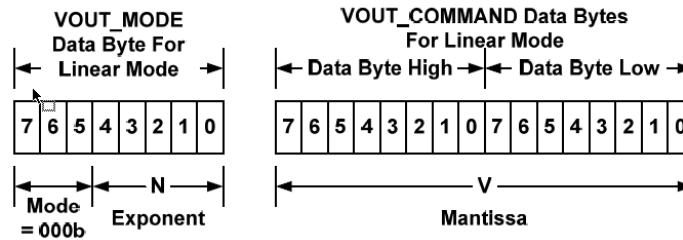

Figure 9. Linear Format Data Bytes

The voltage, in volts, is calculated from the equation Voltage = V·2^N, where:

- V is a 16 bit unsigned binary integer
- N is a 5 bit two’s complement binary integer

Sending the VOUT_MODE command with the address set for writing is not supported. If the system sends a VOUT_MODE command for a write, the power supply shall reject the command, and set the Invalid/Unsupported Data bit in the STATUS_CML register.

7.25 NEW MFR_MAX_IOUT_CAPABILITY (F1h)

The PSU shall provide the Current levels that can support along with their durations for the system to read using a Block Read command with a length of 14 bytes + PEC. The contents of each field are described in the following table.

FIELD NAME	SIZE (BYTES)	MAGNITUDE
Irating	2	Amperes
Ipeak	2	Amperes
Ipeak Duration	2	ms
Ipeak.app	2	Amperes
Ipeak.app Duration	2	ms
Ipeak.max	2	Amperes
Ipeak.max Duration	2	ms

Note: Fields with 0 as value means not supported for a given level.

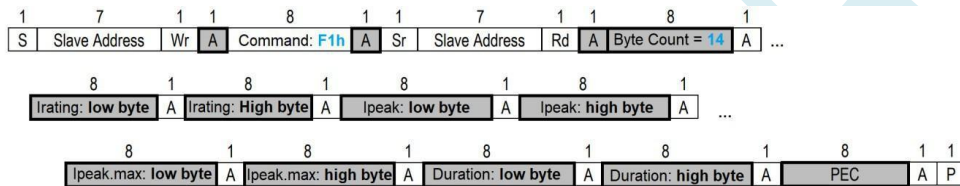

8 COLD REDUNDANCY

8.1 OVERVIEW

Below is a block diagram showing the Cold Redundancy architecture. When the power subsystem is in Cold Redundant mode; only the needed power supply to support the best power delivery efficiency are ON. Any additional power supplies; including the redundant power supply, is in Cold Standby state.

Each power supply has an additional signal that is dedicated to supporting Cold Redundancy; CR_BUS. This signal is a common bus between all power supplies in the system. CR_BUS is asserted (pulled low) when there is a fault in any power supply OR the power supplies output voltage falls below the V_{fault} threshold. Asserting the CR_BUS signal causes all power supplies in Cold Standby state to power ON.

Enabling power supplies to maintain best efficiency is achieved by looking at the Load Share bus voltage and comparing it to a programmed voltage level via a PMBus command.

Whenever there is no Cold Redundant active power supply on the Cold Redundancy bus driving a HIGH level on the bus all power supplies are ON no matter their defined Cold Redundant roll (active or Cold Standby). This guarantees that incorrect programming of the Cold Redundancy states of the power supply will never cause the power subsystem to shut down or become over loaded. The default state of the power subsystem is all power supplies ON. There needs to be at least one power supply in Cold Redundant Active state or Standard Redundant state to allow the Cold Standby state power supplies to go into Cold Standby state.

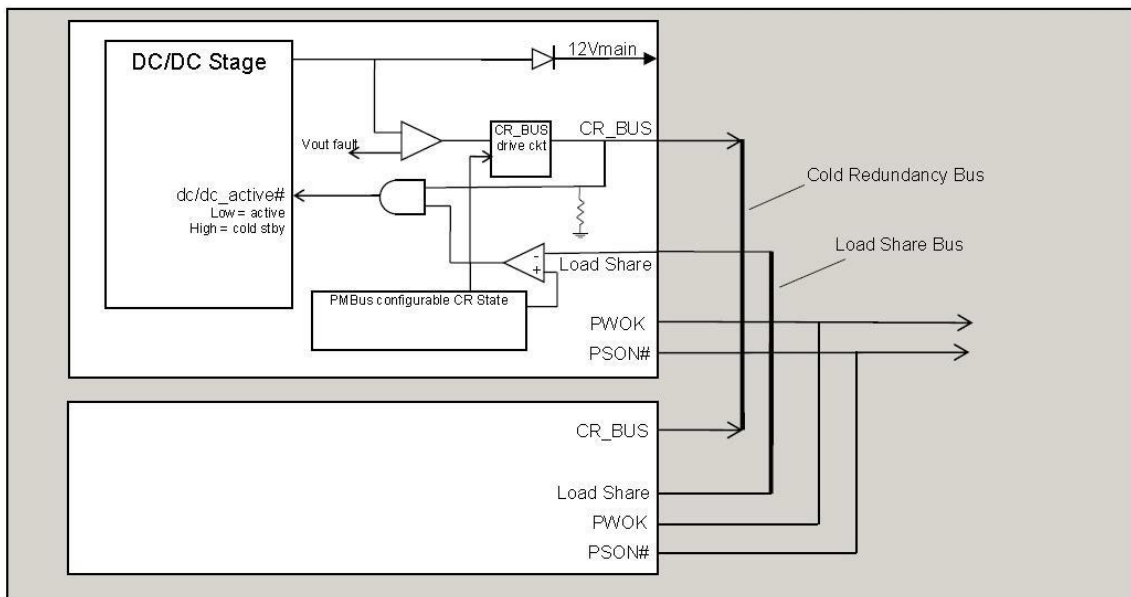

Figure 10. Cold Redundancy 1+1 Functional Block Diagram

CR_BUS	Load Share	dc/dc_active#	Cold Standby Power Supply State(s)
High	< VCR_ON	High	Cold Standby
Low	< VCR_ON	Low	Active
High	> VCR_ON	Low	Active
Low	> VCR_ON	Low	Active

Table 11. Logic Matrix for Cold Standby Power Supplies

8.2 POWERING ON COLD STANDBY SUPPLIES TO MAINTAIN BEST EFFICIENCY

Power supplies in Cold Standby state shall monitor the shared voltage level of the load share signal to sense when it needs to power on. Depending upon which position (1, 2, or 3) the system defines that power supply to be in the Cold standby configuration; will slightly change the load share threshold that the power supply shall power on at.

	Enable Threshold for $V_{CR_ON_EN}$	Disable Threshold for $V_{CR_ON_DIS}$	CR_BUS De-asserted / Asserted States
Standard Redundancy	N/A; Ignore dc/dc_ active# signal; power supply is always ON		OK = Tri-state Fault = Low
Cold Redundant Active	NA; Ignore dc/dc_ active# signal; power supply is always ON		OK = High Fault = Low
Cold Standby 1 (02h)	3.2V (40% of max)	$90\% \times (3.2V \times 1/2) = 1.44V$	OK = Tri-state Fault = Low
Cold Standby 2 (03h)	5.0V (62% of max)	$90\% \times (5.0V \times 2/3) = 3.01V$	OK = Tri-state Fault = Low
Cold Standby 3 (04h)	6.7V (84% of max)	$90\% \times (6.7V \times 3/4) = 4.52V$	OK = Tri-state Fault = Low

Table 12. Example Load Share Threshold for Activating Supplies

Notes:

Maximum load share voltage = 8.0V at 100% of rated output power

These are example load share bus threshold; for any power supply these shall be customized to maintain the best efficiency curve that specific model.

8.3 POWERING ON COLD STANDBY SUPPLIES DURING A FAULT OR OVER CURRENT CONDITION

When an active power supply asserts its CR_BUS signal (pulling it low), all parallel power supplies in Cold standby mode shall power on within 100 μ sec.

8.4 COLD REDUNDANCY SMBUS COMMANDS

The Power Management Bus manufacturer specific command MFR_SPECIFIC_00 is used to configure the operating state of the power supply related to cold redundancy. We will call the command Cold_Redundancy_Config (D0h). Below is the definition of the values used with the Read-Write Byte SMBus protocol with PEC.

VALUE	STATE	DESCRIPTION
00h	Standard Redundancy (default power on state)	Turns the power supply ON into standard redundant load sharing more. The power supply's CR_BUS signal shall be in Tri-state but still pull the bus low if a fault occurs to activate any power supplies still in Cold Standby state.
01h	Cold Redundant Active	Defines this power supply to be the one that is always ON in a cold redundancy configuration.
02h	Cold Standby 1 ¹	Defines the power supply that is first to turn on in a cold redundant configuration as the load increases.
03h	Cold Standby 2 ¹	Defines the power supply that is second to turn on in a cold redundant configuration as the load increases.
04h	Cold Standby 3 ¹	Defines the power supply that is third to turn on in a cold redundant configuration as the load increases.
05h	Always Standby ¹	Defines this power supply to be always in cold redundant configuration no matter what the load condition

¹ When the CR_BUS transitions from a high to a low state; each PSU programmed to be in cold Standby state shall be put into Standard Redundancy mode (Cold_redundancy_Config = 00h). For the power supplies to enter cold Redundancy mode the system must re-program the power supplies using the Cold_redundancy_Config command.

Table 13. Cold_Redundancy_Config (D0h)



8.5 COLD REDUNDANT SIGNALS

There is an additional signal defined supporting Cold Redundancy. This is connected to a bus shared between the power supplies; the CR_BUS.

9 BLACK BOX

9.1 BLACK BOX FUNCTION DESCRIPTION

This specification defines the requirements for power supplies with Power Management Bus capability to store Power Management Bus and other data into non-volatile memory inside the power supply. The data shall be saved to non-volatile memory upon a critical failure that caused the power supply to shutdown. The data can be accessed via the Power Management Bus interface by applying power to the 12Vstby pins. No AC power need to be applied to the power supply.

9.2 WHEN IS DATA SAVED TO THE BLACK BOX?

Data is saved to the Black Box for the following fault events:

- General fault
- Over voltage on output
- Over current on output
- Loss of AC input
- Input voltage fault
- Fan failure
- Over temperature

9.3 BLACK BOX EVENTS

There are two types of data saved in the black box:

- 1) System Tracking Data.
- 2) Power supply event data.

System tracking data is saved to the Black Box whenever the system powers ON or when a power supply is added to the system.

9.4 BLACK BOX PROCESS

- System writes system tracking data to the power supply RAM at power ON.
- System writes the real time clock data to the PSU RAM once every ~5 minutes.
- Power supply tracks number of PSON# and AC power cycles in EEPROM.
- Power supply tracks ON time in EEPROM
- Power supply loads warning and fault event counter data from EEPROM into RAM
- Upon a warning event; the PSU shall increment the associated counter in RAM.
- Upon and fault event the PSU shall increment the associated counter in RAM
- Upon a fault event that causes the PSU to shut down all event data in the PSU's RAM is saved to event data location N in the power supply's EEPROM. This data includes the real time clock, number of AC & PSON# power cycles, PSU ON time, warning event counters and fault event counters.

9.5 RELATED COMMAND OF BLACK BOX

The following command set will be used for Black Box function via the Host System. The commands and protocol used by the Host System and shall be implemented by the microcontroller are defined by this document.

COMMAND CODE	COMMAND NAME	SMBUS TRANSACTION TYPE	NUMBER OF DATA BYTES	REMARK
DCh	MFR_BLACK_BOX	Read only (7)	237	Read the data of the Black box.
DDh	MFR_REAL_TIME	Read/Write (6/7)	4	Read/Write the data of MFR real time.
DEh	MFR_SYSTEM_BLACK_BOX	Read/Write (6/7)	40	Read/Write the data of MFR system black box.
DFh	MFR_BLACKBOX_CONFIG	Read/Write (2/3)	1	Read/Write the data of MFR black box configure.
E0h	MFR_CLEAR_BLACKBOX	Write only (1)	1	Send one byte to clear all data of black box.

1) Command Name: MFR_BLACKBOX

Format: Read Block with PEC (237 bytes)

Code: DCh

ITEM	NUMBER OF BYTES	DESCRIPTION
System Tracking Data		
System top assembly number	10	The system will write its Intel part number for the system top assembly to the power supply when it is powered ON. This is 9 ASCII characters.
System serial number	10	The system shall write the system serial number to the power supply when it is powered ON. This includes the serial number and date code.
Motherboard assembly number	10	The system will write the motherboard Intel part number for the assembly to the power supply when it is powered ON. This is 9 ASCII characters.
Motherboard serial number	10	The system shall write the motherboard's serial number to the power supply when it is powered ON. This includes the serial number and date code.
Present total PSU ON time	3	Total on time of the power supply with PSON # asserted in minutes. LSB = 1 minute.
Present number of AC power cycles	2	Total number of times the power supply powered OFF then back ON due to loss of AC power. This is only counted when the power supply's PSON# signal is asserted. This counter shall stay at FFFFh once the max is reached.
Present number of PSON# power cycles	2	Total number of times the power supply is powered OFF then back ON due to the PSON# signal de-asserting. This is only counted when AC power is present to the power supply. This counter shall stay at FFFFh once the max is reached.
Power supply event data (N)	38	Most recent occurrence of saved black box data
Time Stamp		
Power supply total power on time	3	Total on time of the power supply in minutes. LSB = 1 minute.
Real Time Clock Data from System (reserved for future use)	4	This time stamp does not need to be generated by the power supply. The system rights a real time clock value periodically to the power supply using the MFR_REAL_TIME command. Format is based on IPMI 2.0. Time is an unsigned 32-bit value representing the local time as the number of seconds from 00:00:00, January 1, 1970. This format is sufficient to maintain time stamping with 1-second resolution past the year 2100. This is based on a long-standing UNIX-based standard for time keeping, which represents time as the number of seconds from 00:00:00, January 1, 1970 GMT. Similar time formats are used in ANSI C.
Number of AC power cycles	2	Number of times the power supply powered OFF then back ON due to loss of AC power at the time of the event. This is only counted when the power supply's PSON# signal is asserted.



	Number of PSON# power cycles	2	Number of times the power supply is powered OFF then back ON due to the PSON# signal de-asserting at the time of the event. This is only counted when AC power is present to the power supply.
Power Management Bus			The power supply shall save these Power Management Bus values into the Black Box when a black box event occurs. Fast events may be missed due to the filtering effects of the Power Management Bus sensors.
	STATUS_WORD	2	
	STATUS_IOUT	1	
	STATUS_INPUT	1	
	STATUS_TEMPERTATURE	1	
	STATUS_FAN_1_2	1	
	READ_VIN	2	
	READ_IIN	2	
	READ_IOUT	2	
	READ_TEMPERATURE_1	2	
	READ_TEMPERATURE_2	2	
	READ_FAN_SPEED_1	2	
	READ_PIN	2	
	READ_VOUT	2	
Event Counters			The power supply shall track the total number for each of the following events. These values shall be saved to the black box when a black box event occurs. Once a value has reached 15, it shall stay at 15 and not reset.
	AC shutdown due to under voltage on input	Lower ½	The power supply shall save a count of these critical events to non-volatile memory each time they occur. The counters will increment each time the associated STATUS bit is asserted.
	Thermal shutdown	Upper ½	
	Over current or over power shutdown on output	Lower ½	
	General failure shutdown	Upper ½	
	Fan failure shutdown	Lower ½	
	Shutdown due to over voltage on output	Upper ½	
	Input voltage warning; no shutdown	Lower ½	The power supply shall save into RAM a count of these warning events. Events are count only at the initial assertion of the event/bit. If the event persists without clearing the bit the counter will not be incremented. When the power supply shuts down it shall save these warning event counters to non-volatile memory. The counters will increment each time the associated STATUS bit is asserted.
	Thermal warning; no shutdown	Upper ½	
	Output current power warning; no shutdown	Lower ½	
	Fan slow warning; no shutdown	Upper ½	
Power supply event data (N-1)		38	
Power supply event data (N-2)		38	
Power supply event data (N-3)		38	
Power supply event data (N-4)		38	

2) Name: MFR_REAL_TIME_BLACK_BOX

Format: Write/Read Block with PEC (4 bytes)

Code: DDh

The system shall use this command to periodically write the real time clock data to the power supply.

Format is based on IPMI 2.0. Time is an unsigned 32-bit value representing the local time as the number of seconds from 00:00:00, January 1, 1970. This format is sufficient to maintain time stamping with 1-second resolution past the year 2100. This is based on a long standing UNIX-based standard for time keeping, which represents time as the number of seconds from 00:00:00, January 1, 1970 GMT. Similar time formats are used in ANSIC.

3) Name: MFR_SYSTEM_BLACK_BOX

Format: Write/Read Block with PEC (40 bytes). Low byte first.

Code: DEh

The system uses this command to write the following data to the PSU.

1)

Item	Bytes	
System top assembly number	1-10	Low bytes
System serial number	11-20	
Motherboard assembly number	21-30	
Motherboard serial number	31-40	High bytes

4) Name: MFR_BLACKBOX_CONFIG

Format: Read/Write Byte with PEC

Code: DFh

BIT	VALUE	DESCRIPTION
0	0 = disable black box function 1 = enable black box function	Writing a 1 enables the power supply with black box function. Writing a 0 disables the power supply black box function. The state of MFR_BLACKBOX_CONFIG shall be saved in non-volatile memory so that it is not lost during power cycling. Intel shall receive the power supply with the black box function enabled; bit 0 = '1'.
1-7		Reserved

5) Name: MFR_CLEAR_BLACKBOX

Format: Send Byte with PEC

Code: E0h

The MFR_CLEAR_BLACKBOX command is used to clear all black box records simultaneously.

This command is write only. There is no data byte for this command.

9.6 HARDWARE REQUIREMENTS

The SMBus interface shall be used to access the Black Box data. It may be accessed when the power supply is ON or in standby mode. It also may be accessed when no AC power is applied, and power is only applied at the standby output pins by an external source (12Vstby).



10 BOOTLOADER

10.1 FUNCTION DESCRIPTION

This specification defines the common architecture for in-system power supply firmware updates. It is required that the FW in the main microcontroller on the secondary side of the power supply must be able to be updated in the system using the In-System Firmware Update feature while in the ON state (i.e. with AC power present and PSON# asserted). It is desired that any other microcontroller in the power supply also be able to be updated with this same process (example: primary side microcontroller); however, this is not a requirement at this time.

10.2 FW IMAGE MAPPING

The power supply firmware image shall be made up of two parts; 1) Boot loader; 2) Main program. The system shall contain a backup of the power supply image in its BMC whenever updating the FW to the power supply.

1) Boot Loader:

This is the part of the power supply firmware that is never updated by the system. The power supply shall always be able to recover and power ON into the boot loader mode no matter the state of the power supply's main program. This code shall support the In-System FW update code and basic power supply functions to power ON/OFF, fan cooling, and protections (UV, OV, OC).

2) Main Program:

This is the fully functional power supply program space. There is no requirement to keep a backup image of this code in the power supply since a copy of the power support FW image shall always for kept in the system's BMC.

10.3 POWER SUPPLY OPERATING MODE DURING AND AFTER FIRMWARE UPDATE

1) Firmware update mode in ON state with no power cycle needed:

Power supply may be able to support FW upload in the ON state. The new FW will take effect once it is taken out of FW upload load.

2) Bad image after firmware update:

The power supply must always be able to power on in the boot loader mode with minimal operating capabilities even if the FW image sent to the power supply is bad or corrupt. If in this mode the power supply must be able to still enter the FW upload mode to upload a proper FW image to the PSU.

10.4 TEC3200-12-074NA FIRMWARE IMAGE HEADER

Byte 1	CRC Low Byte	Supplier internal use area 10 bytes
Byte 2	CRC High Byte	
Byte 3	Image Offset Low Byte	
Byte 4	Image Offset High Byte	
Byte 5	Image Size Low Byte	
Byte 6	Image Size High Byte	
Byte 7	Image Sector ID Low Byte	
Byte 8	Image Sector ID High Byte	
Byte 9	Image Update Key Low Byte	
Byte 10	Image Update Key High Byte	
Byte 11	T	Model Name 12 bytes
Byte 12	E	
Byte 13	C	
Byte 14	3	
Byte 15	2	
Byte 16	0	
Byte 17	0	
Byte 18	-	
Byte 19	1	
Byte 20	2	
Byte 21	N	
Byte 22	A	
Byte 23	Not used, for future use	Not used, for future use
Byte 24	FW_MAJOR (Bit 7: down revision control bit, Bit 0-6: Major version).	Firmware Revision 3 bytes; in binary format
Byte 25	FW_MINOR_PRIMARY (not used by system)	
Byte 26	FW_MINOR_SECONDARY	
Byte 27	HW_REVISION_FIRST	Hardware Compatible Revision 2 bytes
Byte 28	HW_REVISION_SECOND	
Byte 29	BLOCK SIZE Low Byte	
Byte 30	BLOCK SIZE High Byte	
Byte 31	Write Time Low Byte	
Byte 32	Write Time High Byte	

10.5 TEC3200-12-074RA FIRMWARE IMAGE HEADER

Byte 1	CRC Low Byte	Supplier internal use area 10 bytes
Byte 2	CRC High Byte	
Byte 3	Image Offset Low Byte	
Byte 4	Image Offset High Byte	
Byte 5	Image Size Low Byte	
Byte 6	Image Size High Byte	
Byte 7	Image Sector ID Low Byte	
Byte 8	Image Sector ID High Byte	
Byte 9	Image Update Key Low Byte	
Byte 10	Image Update Key High Byte	
Byte 11	T	Model Name 12 bytes
Byte 12	E	
Byte 13	C	
Byte 14	3	
Byte 15	2	
Byte 16	0	
Byte 17	0	
Byte 18	-	
Byte 19	1	
Byte 20	2	
Byte 21	R	
Byte 22	A	
Byte 23	Not used, for future use	Not used, for future use
Byte 24	FW_MAJOR (Bit 7: down revision control bit, Bit 0-6: Major version).	Firmware Revision 3 bytes; in binary format
Byte 25	FW_MINOR_PRIMARY (not used by system)	
Byte 26	FW_MINOR_SECONDARY	
Byte 27	HW_REVISION_FIRST	Hardware Compatible Revision 2 bytes
Byte 28	HW_REVISION_SECOND	
Byte 29	BLOCK SIZE Low Byte	
Byte 30	BLOCK SIZE High Byte	
Byte 31	Write Time Low Byte	
Byte 32	Write Time High Byte	

10.6 FIRMWARE UPDATE PROCESS

BMC uses these commands to determine if FW needs updating:
 MFR_FW_REVISION
 MFR_MODEL
 MFR_FW_UPLOAD_MODE
 MFR_FW_COMPATIBILITY
 MFR_FW_UPLOAD_CAPABILITY

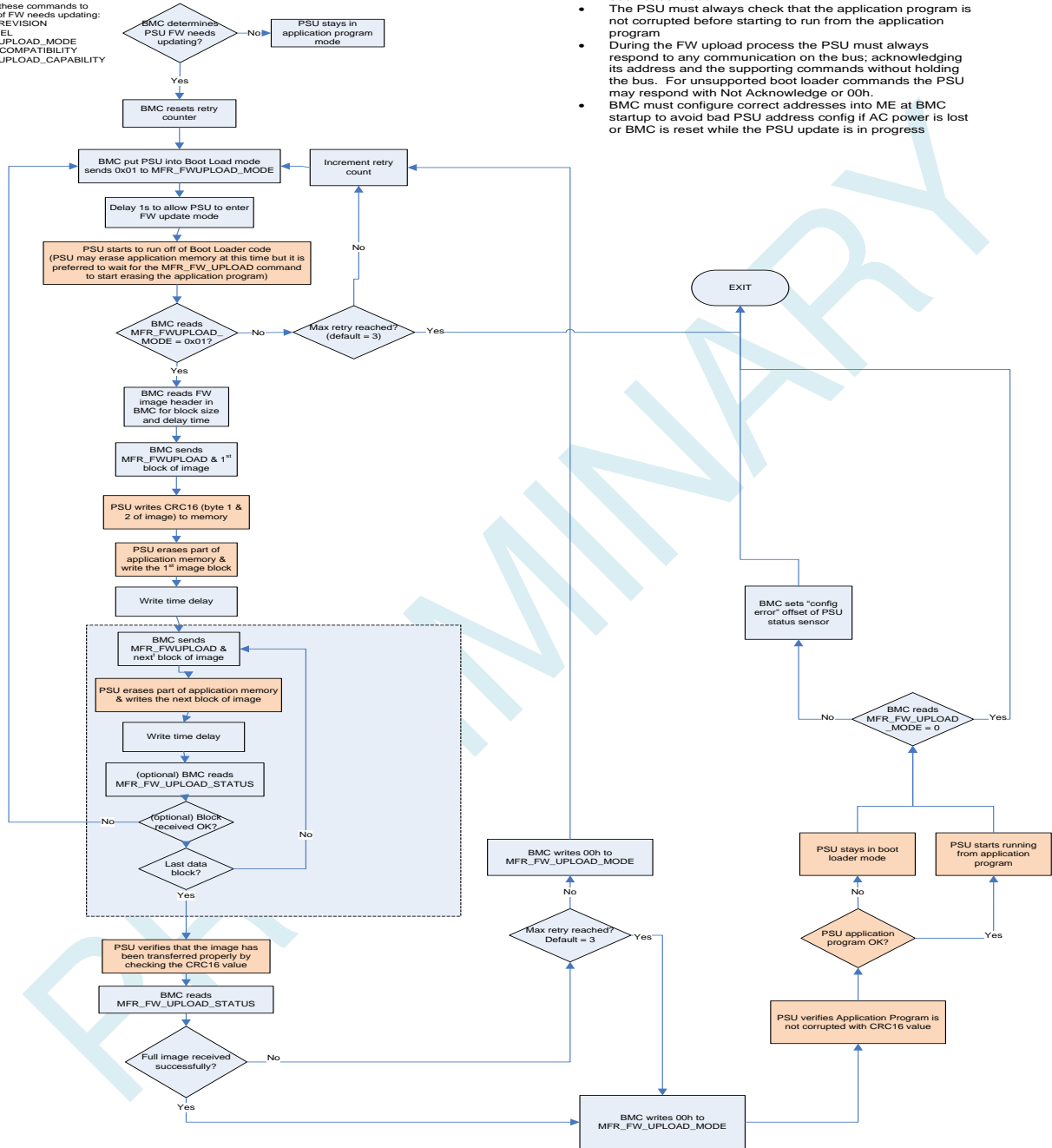

IMPORTANT!

- PSU may be in standby mode or ON mode during FW update process
- If the FW update process is interrupted at any point during the process; the PSU must always be able to return to the boot loader code.
- The PSU must always check that the application program is not corrupted before starting to run from the application program
- During the FW upload process the PSU must always respond to any communication on the bus; acknowledging its address and the supporting commands without holding the bus. For unsupported boot loader commands the PSU may respond with Not Acknowledge or 00h.
- BMC must configure correct addresses into ME at BMC startup to avoid bad PSU address config if AC power is lost or BMC is reset while the PSU update is in progress

Figure 11. PSU Upload Process



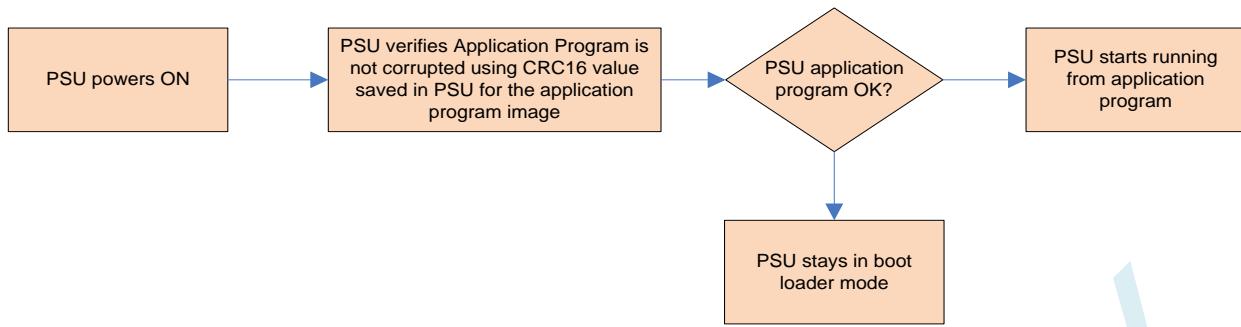

Figure 12. PSU flow during powering ON

PRELIMINARY

10.7 RELATED COMMAND OF BOOTLOADER

1) Name: MFR_HW_COMPATIBILITY

Format: Read Word

Code: D4h

BYTES	VALUE	DESCRIPTION
low	ASCII code for first letter/number of the PSU HW compatibility.	This is a COMPATIBILITY value used to tell if there are any changes in the FW that create an incompatibility with the FW.
high	ASCII code for second letter/number of the PSU HW compatibility.	This value only changes when the PSU HW is changed creating an incompatibility with older versions of FW.

2) Name: MFR_FWUPLOAD_CAPABILITY

Format: Read Byte

Code: D5h

The system can read the power supply's FW upload mode capability using this command. For any given power supply; more than one FW upload mode may be supported. The supported FW upload mode(s) must support updating all available FW in the power supply.

BIT	VALUE	DESCRIPTION
0 (for future use)	1 = PSU support FW uploading in standby mode only	For future use
1 (for future use)	1 = PSU supports FW uploading in ON state; but all the new FW will not take effect until a power cycle with PSON#.	For future use
2	1 = PSU supports FW uploading in the ON state and no power cycle needed	Method used for updating the application program in the power supply
3-7	Reserved	

3) Name: MFR_FWUPLOAD_MODE

Format: Read/Write Byte

Code: D6h

BIT	VALUE	DESCRIPTION
0	0 = exit firmware upload mode 1 = firmware upload mode	Writing a 1 puts the power supply into firmware upload mode and gets it ready to receive the 1st image block via the MFR_FW_UPLOAD command. The system can use this command at any time to restart sending the FW image. Writing a 0 puts the power supply back into normal operating mode. Writing a 1 restarts This command will put the PSU into standby mode if the PSU supports FW update in standby mode only. If the power supply image passed to the PSU is corrupt the power supply shall stay in firmware upload mode even if the system requested the PSU to exit the FW upload mode.
1-7		Reserved

4) Name: MFR_FWUPLOAD

Format: Block Write (block = size as defined by the image header)

Code: D7h

BYTES	VALUE	DESCRIPTION
Block size defined in header	Image header & image data	Command used to send each block of the FW image. Header should follow the format described in section 13.4. The image shall contain block sequencing numbers to make sure the PSU puts the right data blocks into the right memory space on the PSU MCU.



5) Name: MFR_FWUPLOAD_STATUS

Format: Read Word

Code: D8h

At any time during or after the firmware image upload the system can read this command to determine status of the firmware upload process.

Reset: all bits get reset to '0' when the power supply enters FW upload mode.

BIT	DESCRIPTION
0	1 = Full image received successfully
1	1 = Full image not received yet. The PSU will keep this bit asserted until the full image is received by the PSU.
2	1 = Full image received but image is bad or corrupt. Power supply can power ON, but only in 'safe mode' with minimal operating capability.
3 (for future use)	1 = Full image received but image is bad or corrupt. Power supply can power ON and support full features.
4	1 = FW image not supported by PSU. If the PSU receives the image header and determines that the PSU HW does not support the image being sent by the system; it shall not accept the image and it shall assert this bit.
5 – 15	Reserved

6) Name: MFR_FW_REVISION

Format: Block Read, 3 bytes

Code: D9h

BYTE	VALUE	DESCRIPTION
0	0 - 255	Minor revision; secondary
1	0 - 255	Minor revision; primary
2	0 - 255	Bit 7: 1-> Down grading of PSU FW has to be avoided. System BMC can elect to ignore this bit if needed but recommended to follow. 0-> No restriction in downgrading the PSU FW. BMC can update the PSU FW to be in sync with its known version. Bit 0-6: Major revision

7) MFR_MODEL (existing Power Management Bus command)

Code: 9Ah

Maximum of 12 byte value; ending in terminator character.

8) MFR_REVISION (existing Power Management Bus command)

Code: 9Bh

11 ELECTROMAGNETIC COMPATIBILITY

11.1 IMMUNITY

The power supply complies with the limits defined in EN 55024.

PARAMETER	DESCRIPTION / CONDITION	CRITERION
Electrostatic Discharge (ESD)	IEC / EN 61000-4-2; 15 kV air discharge, 8 kV contact discharge	A
Radiated Immunity (RS)	IEC / EN 61000-4-3; 80 ~ 1000 MHz, 10 V/m	A
Electrical Fast Transient / Burst (EFTs)	IEC / EN 61000-4-4; AC Power Port: 1 kV 2 kV	A B
Surge Immunity	IEC / EN 61000-4-5; AC Power Port: line to line: 2 kV / (2 ohm) line to earth: 2 kV / (2 ohm)	A
Conducted Susceptibility (CS)	IEC / EN 61000-4-6; AC Power Port; DC Power Port; Signal Ports and Telecommunication Ports 0.15 ~ 80 MHz, 10 Vrms	A
Power Frequency Magnetic Immunity	IEC / EN 61000-4-8; 50 Hz or 60 Hz, 1 A/m	A
Voltage Dips and Interruptions	IEC / EN 61000-4-11; >95% reduction for 0.5 period, 30% reduction for 25 period, >95% reduction for 250 period	B

11.2 EMISSION

PARAMETER	DESCRIPTION / CONDITION	CRITERION
Conducted & Radiated Emissions	EN 55032 / CISPR 32 / FCC	Class A 6 dB margin
Power Harmonics	EN 61000-3-2	Class A
Voltage Fluctuation and Flicker	EN 61000-3-3	Class A
Acoustic Noise	Variable speed fan(s) incorporated, measured accord. to ECMA 74 and reported according to ISO 9296.	

12 ENVIRONMENTAL

PARAMETER	DESCRIPTION / CONDITION	MIN	NOM	MAX	UNIT
Ambient Temperature	Operating *	TEC3200-12-074NA -5		+55	°C
	Non-Operating **	TEC3200-12-074RA -5		+50	
Humidity	Operating, relative (non-condensing)		5	85	%
	Non-Operating, relative (non-condensing)		5	95	
Altitude	Operating		-50	5 000	m
	Non-Operating		-50	15 240	
Mechanical Shock (non-operating)	50 G Trapezoidal Wave, Velocity change = 170 in. / sec.				
Vibration (non-operating) sinusoidal	5 Hz to 500 Hz at 0.5g RMS at 0.5 octave/min.; dwell 15 min. at each of 3 resonant points				
Vibration (non-operating) random	5 Hz at 0.01g ² /Hz to 20 Hz at 0.02g ² /Hz (slope up); 20 Hz to 500 Hz at 0.02g ² /Hz (flat) Input acceleration = 3.13g RMS; 10 min. per axis for 3 axes on all samples				
Thermal Shock (non-operating)	transition time < 5 min; exposure to extreme temp. 20 min	-40		+70	°C
Audible Noise	@ 100% rated DC load and inlet T _A = 25°C			70	dB

*Maximum rate of change is 10 °C per hour.

**Maximum rate of change is 20 °C per hour

13 RELIABILITY

PARAMETER	DESCRIPTION / CONDITION	MIN	NOM	MAX	UNIT
CMTBF	@ 80% load; T _A = 50°C	200 000			h



Asia-Pacific
+86 755 298 85888

Europe, Middle East
+353 61 49 8941

North America
+1 866 513 2839

© 2024 Bel Fuse Inc.

BCD.20289_1

14 SAFETY / APPROVALS

PARAMETER	DESCRIPTION / CONDITION	
Agency Approvals	<ul style="list-style-type: none"> UL / CSA 62368-1 (USA / Canada) EN / IEC 62368-1 (Europe / International) CB Certificate & Report, IEC 62368-1 (Report includes all country national deviations) CE – Low Voltage Directive 2006/95/EC (Europe) Nordics – EMKO-TSE (74-SEC) 207/94 GB4943.1 – CNCA Certification (China) 	Pending approval
Hi-Pot	Primary to chassis ground	2550 VDC

15 MECHANICAL

PARAMETER	DESCRIPTION / CONDITION	MIN	NOM	MAX	UNIT
Dimensions (W x H x L)			73.5 x 40.0 x 185		mm
			2.89 x 1.57 x 7.28		in
Weight			TBD		g

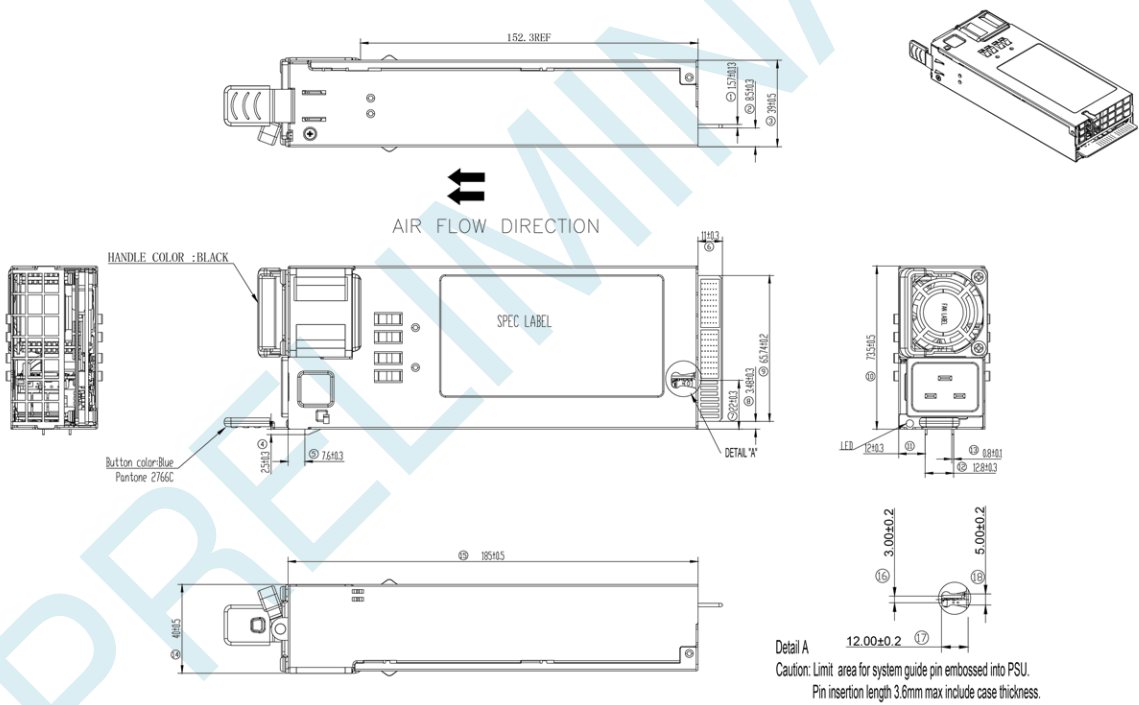

Figure 13. Mechanical Drawing

15.1 AIRFLOW DIRECTION

The normal airflow direction is from the card edge connector side to the AC inlet side of the power supply.
 The reverse airflow direction flows from the AC inlet side of the power supply to the card edge connector side.

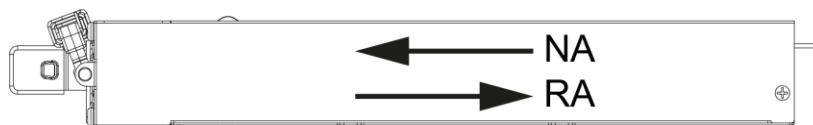

Figure 14. Airflow Direction

15.2 HANDLE RETENTION

The power supply has a handle to assist extraction. The module can be inserted and extracted without the assistance of tools. The power supply has a latch which retains the power supply into the system and prevents the power supply from being inserted or extracted from the system when the AC power cord is pulled into the power supply. The handle protects the operator from any burn hazard being designed in plastic or equivalent material.

16 CONNECTORS

16.1 AC INLET CONNECTOR

The AC input receptacle is an IEC-320 type C20 capable of at least 16 A at 120 VAC rating and 16 A at 250 VAC rating.

16.2 DC OUTPUT CONNECTOR PIN LOCATIONS

The power supply has a card edge output connection for power and signal that is compatible with a 2x25 Power Card Edge connector (equivalent to 2x25 pin configuration of the FCI power card connector 10035388-102LF or OUPIIN power card connector 9393-F4P50N11ACB30DA).

PIN NO.	PIN NAME	PIN TYPE	PIN LENGTH	DESCRIPTION
A1~A9 B1~B9	GND	12VOUT main & VSB Return	Long	12V _{OUT} main & V _{SB} Return
A10~A18 B10~B18	12V _{OUT}	12VOUT main output	Standard	12V _{OUT} main output
A19	SDA	I / O	Short	SMBus / PMBus Data
A20	SCL	I / O	Short	SMBus / PMBus Clock
A21	PSON#	Input	Short	Active low; 12V _{OUT} main output on/off control
A22	SMBAlert#	Output	Standard	Active low; I ² C alert signal (interrupt)
A23	RETURN Sense	Analog Input	Standard	12V _{OUT} main output Remote Sense -
A24	12V _{OUT} Remote Sense	Analog Input	Standard	12V _{OUT} main output remote sense +
A25	PWOK	Output	Standard	Active high; indicate 12V _{OUT} main is valid
B19	A0	Input	Standard	Power Management Bus address 0
B20	A1	Input	Standard	Power Management Bus address 1
B21	12V Standby V _{SB}	Aux Power	Standard	Standby voltage
B22	Cold Redundant Bus	I / O	Standard	Cold Redundant Bus
B23	12V _{OUT} Load Share Bus	Analog Output	Standard	12V _{OUT} main output load current sharing
B24	PRESENT#	Input	Standard	Power Supply Present
B25	VIN_GOOD#	Output	Short	Indicate the status of input voltage

For more information on these products consult: tech.support@psbel.com

NUCLEAR AND MEDICAL APPLICATIONS - Products are not designed or intended for use as critical components in life support systems, equipment used in hazardous environments, or nuclear control systems.

TECHNICAL REVISIONS - The appearance of products, including safety agency certifications pictured on labels, may change depending on the date manufactured. Specifications are subject to change without notice.



Asia-Pacific
+86 755 298 85888

Europe, Middle East
+353 61 49 8941

North America
+1 866 513 2839

© 2024 Bel Fuse Inc.

BCD.20289_1