

**SERIES:** SDI50-UD | **DESCRIPTION:** AC-DC POWER SUPPLY

**FEATURES**

- DoE Level VI, CoC Tier 2 efficiency
- 50 W power
- universal input (90~264 Vac)
- compact size
- single regulated output from 9~48 Vdc
- over voltage and short circuit protections
- UL/cUL and PSE safety approvals
- custom designs available
- certified to 60950-1 and 62368-1 standards



MODEL	output voltage	output current max	output power max	ripple and noise <sup>1</sup> max	efficiency level <sup>2</sup>
	(Vdc)	(A)	(W)	(mVp-p)	
SDI50-9-UD	9	5	45	100	VI
SDI50-12-UD	12	4.2	50	120	VI
SDI50-15-UD	15	3.34	50	150	VI
SDI50-18-UD	18	2.78	50	180	VI
SDI50-19-UD	19	2.64	50	190	VI
SDI50-24-UD	24	2.1	50	240	VI
SDI50-48-UD	48	1.05	50	480	VI

Notes: 1. At full load, nominal input, 20 MHz bandwidth oscilloscope, each output terminated with 0.1 µF multilayer ceramic and 10 µF low ESR electrolytic capacitors.  
2. CoC Tier 2 compliant

**PART NUMBER KEY**

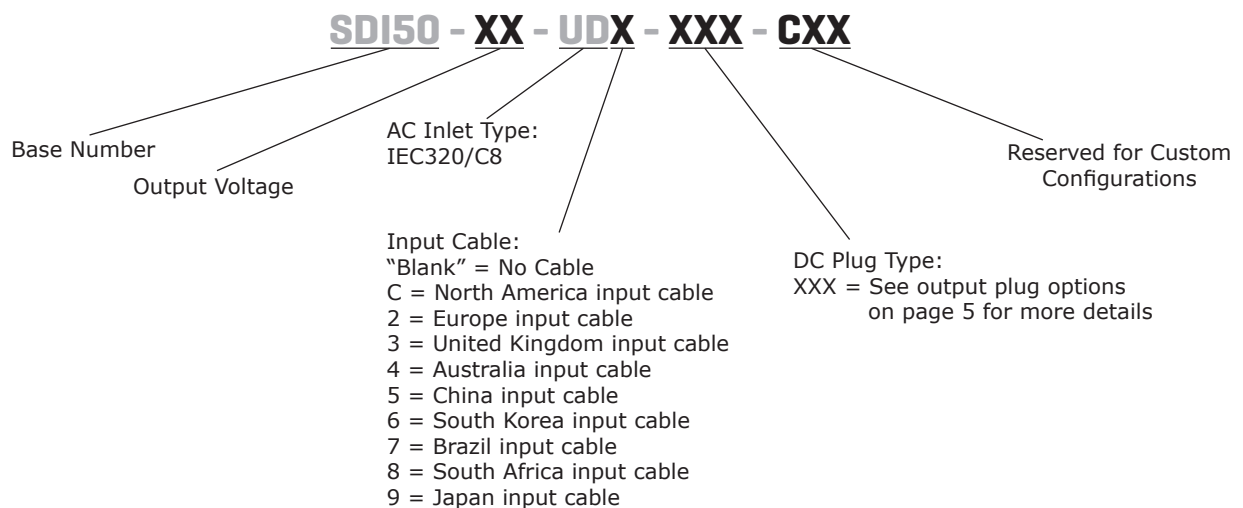

**INPUT**

parameter	conditions/description	min	typ	max	units
voltage		90		264	Vac
frequency		47		63	Hz
current				1.2	A
inrush current	at 230 Vac, full load, 25°C, cold start			70	A
leakage current				0.25	mA
no load power consumption	at 230 Vac 9 Vdc model all other models			0.10 0.15	W W

**OUTPUT**

parameter	conditions/description	min	typ	max	units
regulation			±5		%

**PROTECTIONS**

parameter	conditions/description	min	typ	max	units
over voltage protection	output latch off			180	%
over current protection	output shut down, auto recovery			180	%
short circuit protection	output shut down, auto recovery				

**SAFETY & COMPLIANCE**

parameter	conditions/description	min	typ	max	units
isolation voltage	input to output at 10 mA for 1 minute		3,000		Vac
isolation resistance	input to output at 500 Vdc	10			MΩ
safety approvals	UL/cUL (60950-1, 62368-1), PSE, LPS, UKCA				
EMI/EMC	FCC Part 15B Class B, CE				
MTBF	as per Telcordia SR-332, 25°C	300,000			hours
RoHS	yes				

**ENVIRONMENTAL**

parameter	conditions/description	min	typ	max	units
operating temperature		0		40	°C
storage temperature		-20		80	°C
operating humidity	non-condensing	20		80	%
storage humidity	non-condensing	10		90	%

## MECHANICAL

parameter	conditions/description	min	typ	max	units
dimensions	115 x 53 x 38				mm
inlet plug	IEC320/C8				
weight	without ac cord		310		g

## MECHANICAL DRAWING

units: mm  
tolerance: ±1.0 mm

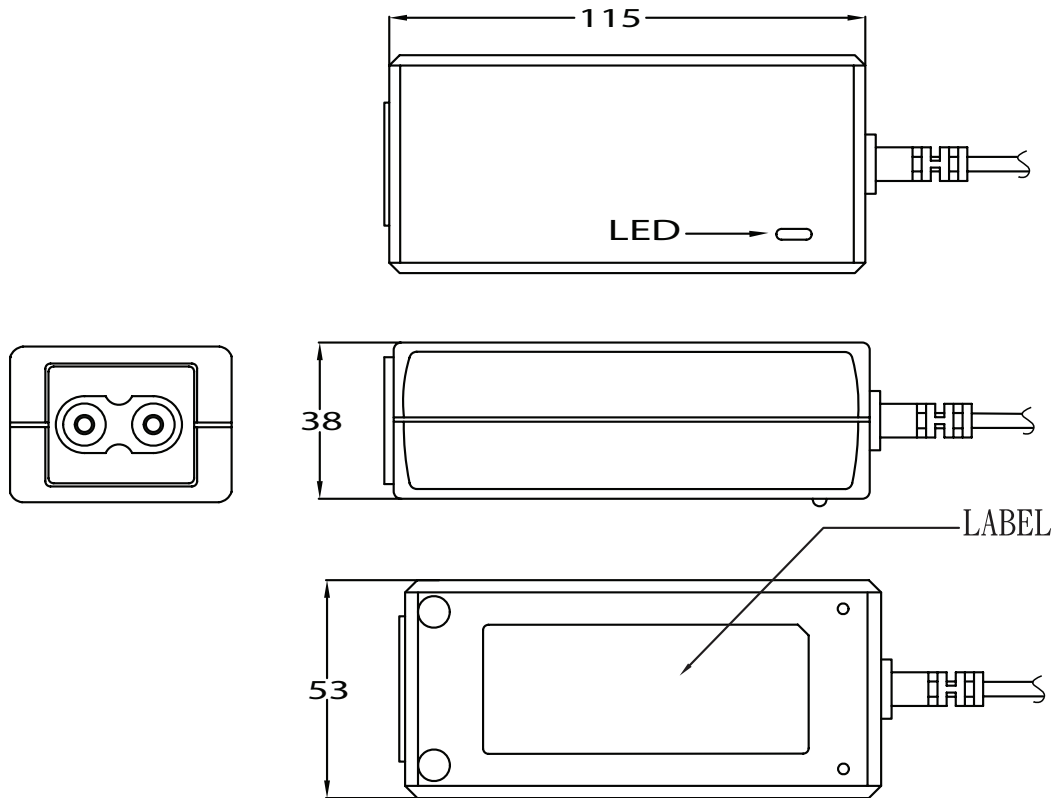

## DC CORD

units: mm

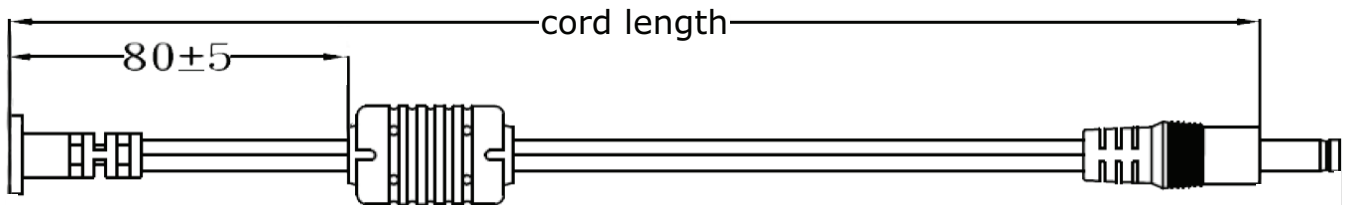
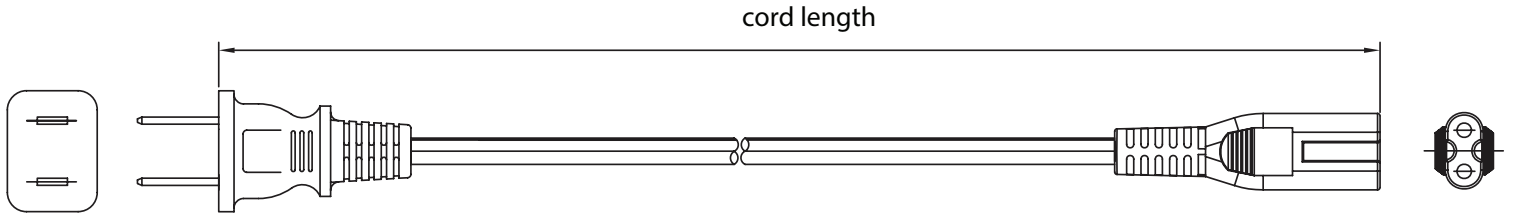

**Table 1**

MODEL NO.	CABLE	CORD LENGTH
SDI50-9-UD	UL2468, 16 AWG	1,500 mm ±30
SDI50-12-UD	UL2468, 18 AWG	1,500 mm ±30
SDI50-15-UD	UL2468, 18 AWG	1,500 mm ±30
SDI50-18-UD	UL2468, 18 AWG	1,500 mm ±30
SDI50-19-UD	UL2468, 18 AWG	1,500 mm ±30
SDI50-24-UD	UL2468, 18 AWG	1,500 mm ±30
SDI50-48-UD	UL2468, 20 AWG	1,500 mm ±30

## AC CORD

units: mm



### NORTH AMERICA

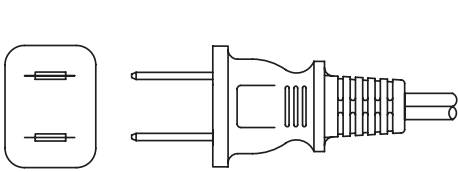

### EUROPE

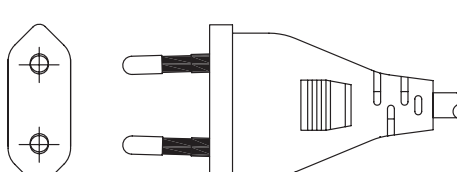

### UNITED KINGDOM

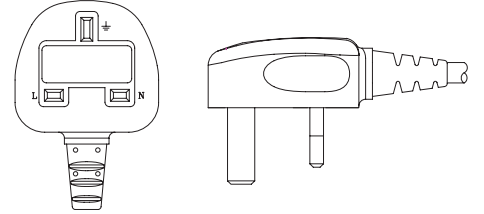

### AUSTRALIA

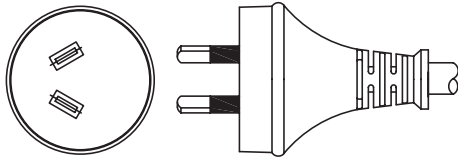

### CHINA

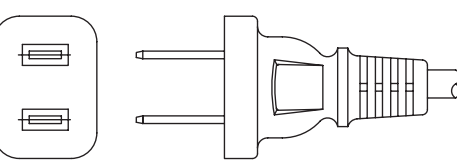

### SOUTH KOREA

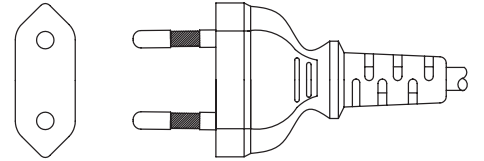

### BRAZIL

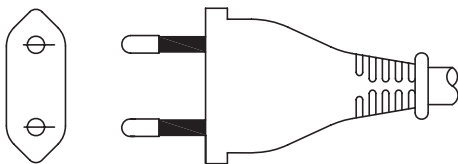

### SOUTH AFRICA

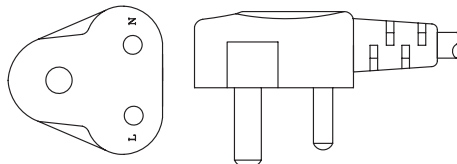

### JAPAN

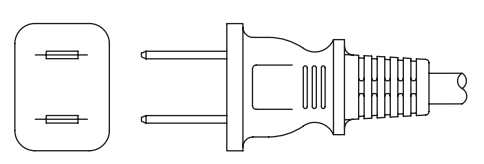

**Table 2**

AC INPUT	CORD LENGTH
North America	1,830 mm ±50
Europe	1,830 mm ±50
United Kingdom	1,830 mm ±30
Australia	1,830 mm ±30
China	1,830 mm ±30
South Korea	1,830 mm ±50
Brazil	1,830 mm ±30
South Africa	1,830 mm ±50
Japan	1,830 mm ±50

## DC PLUG TYPE PART NUMBER KEY

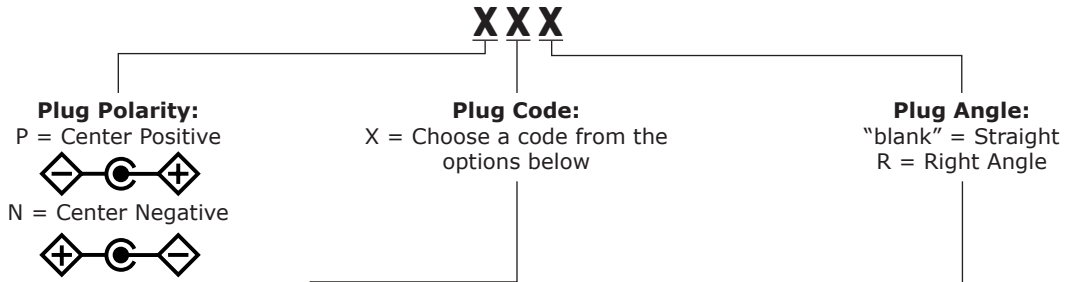

Plug Polarity		Code		Dimensions (mm)			Plug Angle	
Center Pos.	Center Neg.	Option	Type	A	B	C	Straight	Right
•	•	5	Standard	5.5	2.1	9.5	•	•
•	•	6	Standard	5.5	2.5	9.5	•	•
•	•	7	Standard	3.5	1.35	9.5	•	•
•	•	8	Standard	3.8	1.35	9.5	•	•
•	•	9	Standard	3.8	1.05	9.5	•	•
•	•	10	Locking <sup>2</sup>	5.5	2.1	9.5	•	N/A
•	•	11	Locking <sup>2</sup>	5.5	2.5	9.5	•	N/A
•	•	12	EIAJ-1	2.35	0.7	9.5	•	•
•	•	13	EIAJ-2	4.0	1.7	9.5	•	•
•	•	14	EIAJ-3	4.75	1.7	9.5	•	•
N/A	N/A	ST	Stripped & Tinned			N/A	N/A	

Note: 1. Contact CUI for additional plug options  
 2. Maximum insertion depth is 10mm

### Standard

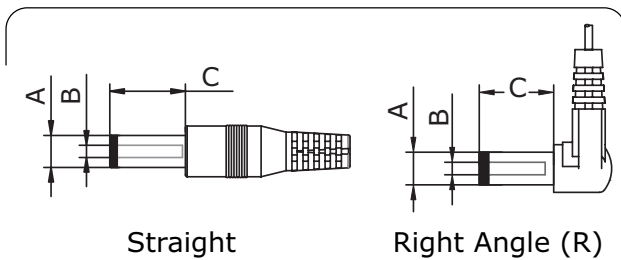

### EIAJ

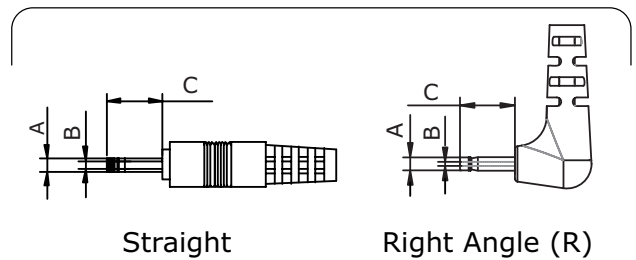

### Locking

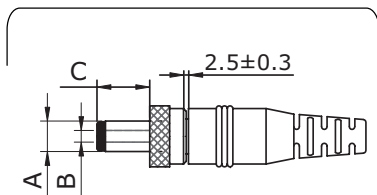

### Stripped & Tinned

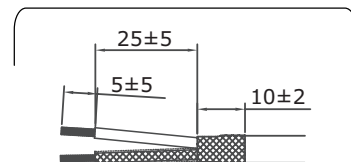

## REVISION HISTORY

---

rev.	description	date
1.0	initial release	05/13/2015
1.01	updated datasheet	09/15/2016
1.02	added 62368-1 standard	08/31/2018
1.03	removed GS safety approval	03/02/2020
1.04	dc cord AWG updated	06/09/2020
1.05	UKCA added to specification	08/11/2021
1.06	plug polarity symbols updated	09/16/2021
1.07	dc plugs updated	05/23/2022

The revision history provided is for informational purposes only and is believed to be accurate.



**Headquarters**  
20050 SW 112th Ave.  
Tualatin, OR 97062  
**800.275.4899**

Fax 503.612.2383  
**cui.com**  
techsupport@cui.com

CUI offers a two (2) year limited warranty. Complete warranty information is listed on our website.

CUI reserves the right to make changes to the product at any time without notice. Information provided by CUI is believed to be accurate and reliable. However, no responsibility is assumed by CUI for its use, nor for any infringements of patents or other rights of third parties which may result from its use.

CUI products are not authorized or warranted for use as critical components in equipment that requires an extremely high level of reliability. A critical component is any component of a life support device or system whose failure to perform can be reasonably expected to cause the failure of the life support device or system, or to affect its safety or effectiveness.